

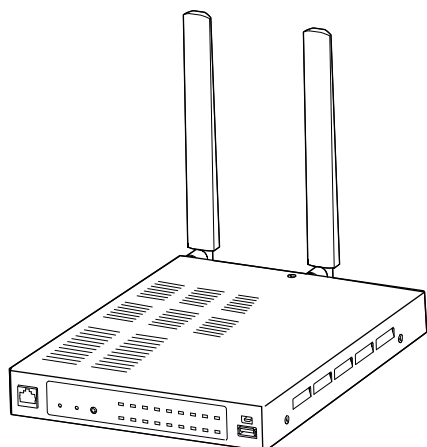

INSTALLATION GUIDE

RoIP GATEWAY **VE-PG4**



Icom Inc.

INTRODUCTION

1. BEFORE USING THE VE-PG4

2. SETTING UP THE TRANSCEIVERS

3. WIRELESS LAN TRANSCEIVERS

4. CONFIGURING THE PBX SYSTEM

5. MAINTENANCE

6. FOR YOUR INFORMATION

INTRODUCTION

Thank you for choosing this Icom product.

The VE-PG4 RoIP GATEWAY is designed and built with Icom's IP network technology.

We hope you agree with Icom's philosophy of "technology first." Many hours of research and development went into the design of your VE-PG4.

Icom is not responsible for the destruction, damage to, or performance of any Icom or non-Icom equipment, if the malfunction is because of:

- Force majeure, including, but not limited to, fires, earthquakes, storms, floods, lightning, other natural disasters, disturbances, riots, war, or radioactive contamination.
- The use of Icom transceivers with any equipment that is not manufactured or approved by Icom.

ALL RIGHTS RESERVED. This document contains material protected under International and Domestic Copyright Laws and Treaties. Any unauthorized reprint or use of this material is prohibited. No part of this document may be reproduced or transmitted in any form or by any means, electronic or mechanical, including photocopying, recording, or by any information storage and retrieval system without express written permission from Icom Incorporated.

All stated specifications and design are subject to change without notice or obligation.

Icom, Icom Inc. and the Icom logo are registered trademarks of Icom Incorporated (Japan) in Japan, the United States, the United Kingdom, Germany, France, Spain, Russia, Australia, New Zealand, and/or other countries.

Microsoft and Windows are registered trademarks of Microsoft Corporation in the United States and/or other countries.

AMBE+2 is a trademark and property of Digital Voice Systems Inc.

All other products or brands are registered trademarks or trademarks of their respective holders.

Voice coding technology

The AMBE+2™ voice coding Technology embodied in this product is protected by intellectual property rights including patent rights, copyrights and trade secrets of Digital Voice Systems, Inc. This voice coding Technology is licensed solely for use within this Communications Equipment.

The user of this Technology is explicitly prohibited from attempting to extract, remove, decompile, reverse engineer, or disassemble the Object Code, or in any other way convert the Object Code into a human-readable form. U.S. Patent Nos.

#8,595,002, #8,359,197, #8,315,860, #8,200,497, #7,970,606, and #6,912,495 B2.

Features

- The VE-PG4 RoIP Gateway enables you to communicate between transceivers, wireless LAN transceivers or IP telephones, that are connected to the RoIP Gateway, through IP networks.
Controls IP transceivers and wireless LAN transceivers through a 4G/3G line.
 - ① Panasonic KX series IP telephones are usable, as of May, 2019.
 - ① The 3G/4G line is required to connect to the IP transceiver controller.
 - ① A total of up to 50 wireless LAN transceivers and IP100FSs remote communicator, and up to 25 IP telephones can be registered and used in the VE-PG4 system.
- Connects to speakers in the system,
- Enables emergency calls to linked transceivers and speakers, and monitors unusual operation of the linked transceivers.
- A USB flash drive can be connected to the USB port for such as recording the audio communication between transceivers and telephones, updating the firmware and backing up or restoring the settings.
- Supports SNMP for network management.
- IP filtering function that restricts access from unknown network addresses.
- Automatic switching between 10BASE-T, 100BASE-TX, and 1000BASE-T.

① This document is described based on the VE-PG4 firmware version 1.10.

Supported Icom radio products

(As of May, 2019)

The following Icom transceivers can be connected to a VE-PG4.

① Some models may not be available in some countries. Ask your dealer for details.

Category	Model	Description in this manual	Mode	Connected to	Cable (optional)
Marine	IC-M604A/ IC-M605 series	IC-M604 IC-M605	Analog	[EXT] (EXT I/O)	OPC-2273
Land	IC-F5060 series/ IC-F6060 series	IC-F5060/F6060	Analog	[EXT] (EXT I/O)	OPC-2275
Aviation	IC-A120 series	IC-A120	Analog	[EXT] (EXT I/O)	OPC-2275
Repeater	IC-FR5000 series/ IC-FR6000 series	IC-FR5000/ FR6000	Analog	[EXT] (EXT I/O)	OPC-2390
			NXDN Type-D/ dPMR Mode 2	[LAN]*	LAN (User supplied)
Satellite PTT	IC-SAT100	IC-SAT100	Analog	[EXT] (EXT I/O)	OPC-2412

*The optional UC-FR5000 must be installed.

Options

(As of May, 2019)

- OPC-2273 CONNECTION CABLE for the IC-M604A/M605 (Length: Approximately 5 m/ 16.4 ft)



- OPC-2275 CONNECTION CABLE for the IC-F5060/F6060 and IC-A120 (Length: Approximately 5 m/ 16.4 ft)

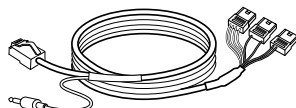

- OPC-2276 CONNECTION CABLE for the Icom microphone and speaker (Length: Approximately 5 m/ 16.4 ft)



- OPC-2389 CONNECTION CABLE for the Icom serial communication device (Length: Approximately 5 m/ 16.4 ft)

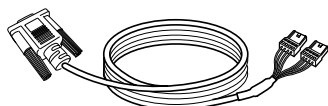

- OPC-2390 CONNECTION CABLE for the IC-FR5000/FR6000 (Length: Approximately 5 m/ 16.4 ft)



- OPC-2412 CONNECTION CABLE for the IC-SAT100 (Length: Approximately 5 m/ 16.4 ft)



- CT-24*1 DIGITAL VOICE CONVERTER to communicate using AMBE+2™ codec.



- HM-241 SPEAKER MICROPHONE (Future product) to directly make a call on the VE-PG4.

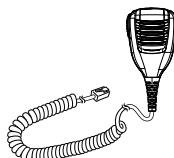

- HM-152 MICROPHONE to make a call on the VE-PG4.*2

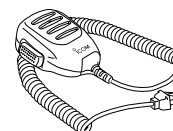

- SM-26 DESKTOP MICROPHONE to make a call on the VE-PG4.*2

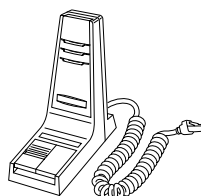

- RC-FS10 REMOTE COMMUNICATOR to create a virtual radio or simple dispatcher on a PC.

① Necessary to communicate with an Icom repeater.

*1 The VE-PG4 has 4 internal AMBE+2 Vocoder corresponding to the CT-24. When you need more than 5 AMBE+2 Vocoder you can add up to 2 CT-24s to the RoIP Gateway, according to the combination of the connected devices or using voice protocol.

Refer to the Section 5 in the Operating guide.

*2 An optional OPC-2276 CONNECTION CABLE is required.

Network and system default settings

Menu Item	Screen	Setting Item	Option	Value
Network Settings	IP Address	IP Address	IP Address	192.168.0.1
			Subnet Mask	255.255.255.0
	DHCP Server	DHCP Server	DHCP Server	Disable
Router Settings	WAN	Connection Type	Connection Type	LAN Port
Connection Port Settings	EXT I/O (EXT)	EXT I/O Port Mode	Connected Unit	Transceiver (EXT 1/2)
			EXT I/O Unit (EXT 3/4)	
		EXT I/O	EXT I/O Port	EXT I/O 1 (EXT 1)
Management	Administrator	Administrator Password	Transceiver Model	IC-F5060/F6060
			Username	admin (fixed)
			Current Password:	admin (lower case)

- ① See the Operating guide for more details on above settings.
- ① The Administrator's Username (admin) cannot be changed.

To prevent unauthorized access

- You must choose a strong password and change it occasionally.
- Choose one that is not easy to guess.
- Use numbers, characters and letters (both lower and upper case).

Confirming the MAC address

The MAC address of the built-in WAN or LAN module of the VE-PG4 is shown on the Serial label at the bottom of the product.

- ① You can also check the MAC address on the setting screen. See the Operating guide for details.

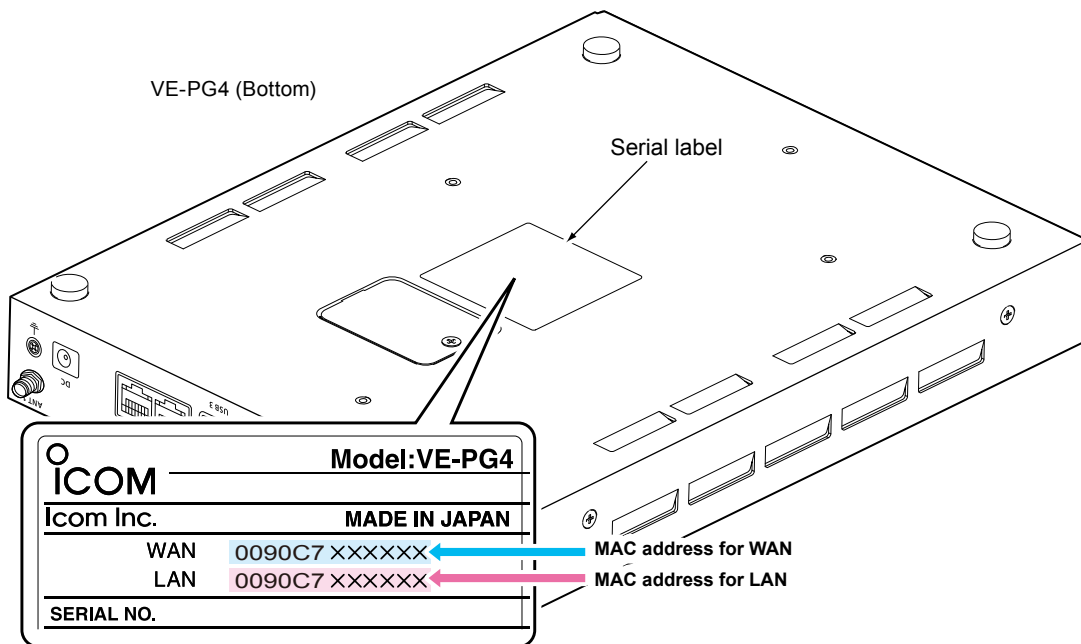

The contents of the serial label may vary, depending on the version.

ABOUT THE CONSTRUCTION OF THE MANUAL

You can use the following manuals to understand and operate this RoIP Gateway.

Precautions (Comes with the RoIP Gateway)

Instructions for the connections, initialization, and precautions.

Installation guide (This manual, PDF type)

Instructions for the system requirements, the system setup basics, maintenance, and the specifications. It can be downloaded from the Icom website.

Operating guide (PDF type)

The detailed references for the settings in the RoIP Gateway setting screen. It can be downloaded from the Icom website.

Panel description	1-2
■ Front panel	1-2
■ Rear panel	1-6
■ Side and bottom panels	1-8
Feature description	1-9
■ Expanding communication coverage	1-9
■ Communication between a VoIP telephone and a transceiver	1-9
■ Controlling wireless LAN transceivers	1-10
■ Connecting to the IP transceiver controllers	1-12
■ The router function	1-12
■ The VPN function	1-12
■ Audio recorder function	1-12
■ Virtual serial port	1-12
Installation and connections	1-13
■ Attaching the magnet legs	1-13
■ Attaching the antennas	1-14
■ Setting a static IP address to a PC	1-15
■ Connecting the cables and the PC	1-16
The setting screen	1-17
■ Accessing the setting screen.....	1-17
■ Setting screen description	1-18
■ Changing the IP address on the setting screen	1-19

Panel description

■ Front panel

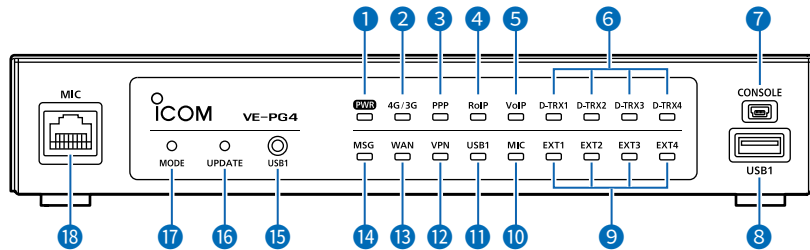

INDICATORS

- 1 [PWR]**

 - Lights green: Power is ON
 - ⚡ Blinks green: Booting up
 - ⚡ Blinks red: UID indication
 - Not lit: Power is OFF

- 2 [4G/3G]**

 - Lights green: RSSI level 2 or more in the 4G mode
 - ⚡ Blinks green: RSSI level 0 ~ 1 in the 4G mode
 - Lights red: RSSI level 2 or more in the 3G mode
 - ⚡ Blinks red: RSSI level 0 ~ 1 in the 3G mode
 - Not lit: Out of the service range, or the SIM card is not attached

- 3 [PPP]**

 - Lights green: Authenticated to a 4G or 3G line
 - Not lit: Condition other than the above

- 4 [RoIP]**

 - Lights green: In audio/data communication with IP transceivers (Receive)
 - Lights orange: In audio/data communication with IP transceivers (Full duplex)
 - Lights red: In audio/data communication with IP transceivers (Transmit)
 - Not lit: Condition other than the above

- 5 [VoIP]**

 - Lights green: Registration succeed (All entries)
 - ⚡ Blinks green: 1 or more phone lines are communicating
 - ⚡ Blinks red: 1 or more registrations failed
 - Not lit: No registration/Connecting

- 6 [D-TRX1] ~ [D-TRX4]**

 - Lights green: In the communication with digital transceivers. (Receive)
 - Lights orange: In the communication with digital transceivers. (Full duplex)
 - Lights red: In the communication with digital transceivers (Transmit)
 - Not lit: Condition other than the above

1 BEFORE USING THE VE-PG4

Panel description

■ Front panel

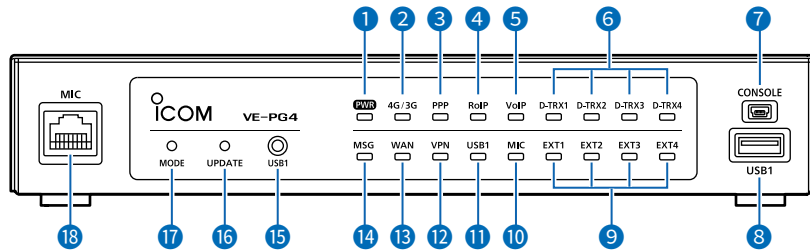

7 [CONSOLE] PORT (USB 2.0/1.1)

Connect a USB (mini B type) cable (user supplied) to remotely configure the VE-PG4 from a PC using a terminal software (user supplied.)

About the USB driver

To use the [CONSOLE] port, the USB driver for the Icom network devices is required.

Download it from the Icom website and install it on your PC.

<http://www.icom.co.jp/world/support/>

8 [USB1] PORT (USB 3.0)

Connect a USB flash drive (user supplied) to save or restore settings or to update the firmware.

- ① You can save the recorded audio on a data storage device through the USB port. Only one storage device can be connected to the USB port at a time.
- ① Be sure to back up the data on the USB flash drive before connecting it to the VE-PG4.
- ① A USB flash drive, such as one with biometric authentication, or one with password protection is not supported.
- ① Some USB devices may not be usable with the VE-PG4.
- ① The VE-PG4 accepts up to two CT-24s for optional AMBE+2 vocoders.

Panel description

■ Front panel

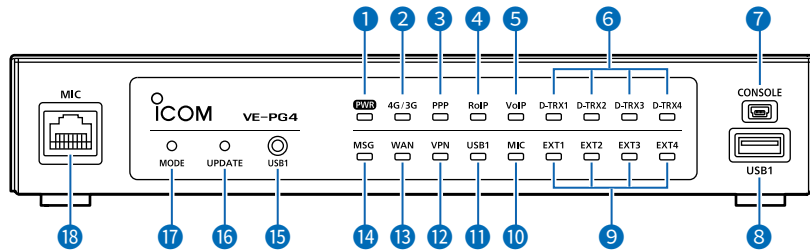

INDICATORS

- ⑨ [EXT1] ~ [EXT4]

 - Lights green: Receiving an audio signal.
 - Lights orange: In audio/data communication with transceivers (Full duplex).
 - Lights red: In audio/data communication with transceivers (Receive).
 - Not lit: Condition other than the above.

- ⑩ [MIC]

 - Lights green: Receiving an audio signal through [MIC].
 - Lights orange: Communicating through [MIC] (Full duplex).
 - Lights red: Sending an audio signal through [MIC].

- ⑪ [USB1]

 - Lights green: A USB flash drive is connected.
 - ☀ Blinks green: Accessing the USB flash drive.
 - Lights red: Failed loading a firmware or backup data from the USB flash drive.
 - Not lit: Condition other than the above.

- ⑫ [VPN]

 - Lights green: At least one IPsec tunnel has been established.
 - Not lit: Not connected./VPN not used./Invalid setting.

- ⑬ [WAN]

 - Lights green: Connected to the WAN line.
Authentication succeeded (PPPoE)
Succeed to obtain IP address (DHCP client)
 - ☀ Blinks red: Authentication error/failed (PPPoE)
Failed to obtain IP address (DHCP client)
 - Not lit: Condition other than the above.

- ⑭ [MSG]

 - Lights green: A firmware update is ready.
 - ☀ Blinks green: Initialization is in progress./Firmware update is in progress.
 - Not lit: Condition other than the above.

1 BEFORE USING THE VE-PG4

Panel description

■ Front panel

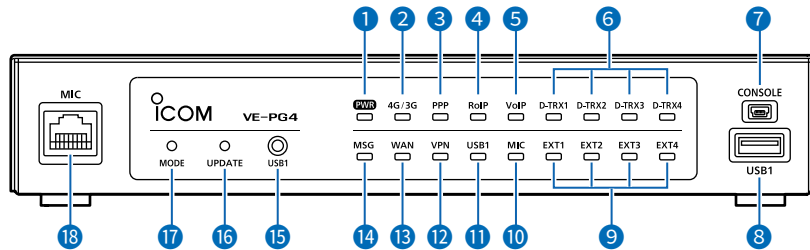

- 15 <USB1> BUTTON** When removing the USB flash drive, hold down this button until [USB1] (11) turns OFF.
- 16 <UPDATE> BUTTON** When [MSG] lights green, a firmware update is ready. Hold down this button until [MSG] blinks green to update the firmware.
① When you do not use the 4G or 3G line, an internet connection is necessary for the firmware update through the network.
① Use a pin to push the button.
- 17 <MODE> BUTTON** Push to initialize the settings. See Section 5 for details.
① Use a pin to push the button.
- 18 [MIC] PORT** Connect to the optional speaker-microphone. Insert the speaker-microphone connector until it clicks.
① Turn OFF the VE-PG4 before connecting or disconnecting the speaker-microphone.
① Never connect a LAN cable to the [MIC] port.
① The [MIC] and [EXT1] ports cannot be used at the same time. While a speaker-microphone is connected, audio input to or output from the [EXT1] port on the rear panel is muted.

Panel description

Rear panel

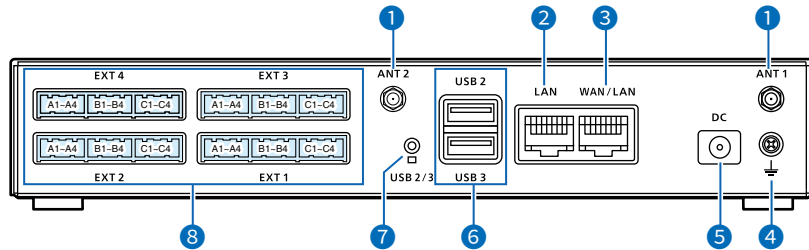

1 [ANT1]/[ANT2] CONNECTORS

Attach antennas to communicate with IP transceivers through the 4G/3G line. Always attach two antennas. (p.1-14)
[ANT1] is also used for the GPS function.

2 [LAN] PORT (RJ-45 type)

Connect a network device such as a Switch.

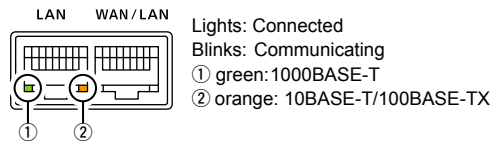

3 [WAN/LAN] PORT (RJ-45 type)

Connect a proper device, depending on the Line Type setting. (Router Settings > WAN > Connection Type)
See the Operating guide for details.

- Used as a LAN port (default)
Connect a network device such as a Switch or Router modem.

- DHCP Client, Static IP, or PPPoE
Connect a bridge modem (ADSL, VDSL or CATV) or FTTH terminal.

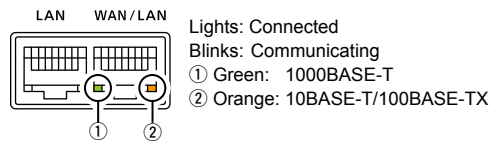

4 [GND] TERMINAL

Connect to ground.

5 [DC] JACK

Connect the supplied power adapter.

Panel description

■ Rear panel

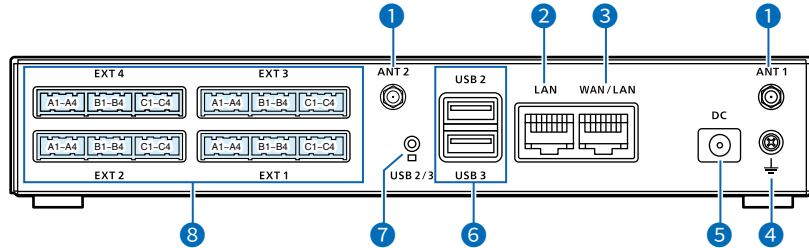

6 [USB2]/[USB3] PORTS (USB3.0)

Connect a USB flash drive (user supplied) to restore the settings or to update the firmware.

- ① You can save the recorded audio on a data storage device through the USB port. Only one storage device can be connected to the USB port at a time.
- ① Be sure to back up the data on the USB flash drive before connecting it to the VE-PG4.
- ① A USB flash drive such as one with biometric authentication, or one with password protection, is not supported.
- ① Some USB devices may not be usable with the VE-PG4.
- ① The VE-PG4 accepts up to two CT-24s for optional AMBE+2 vocoder.

7 <USB2/3> BUTTON

Before removing the USB flash drive, hold down this button until the indicator below the button turns OFF.

8 [EXT1] ~ [EXT4] PORTS ...

Connect external devices or transceivers.

- ① Be sure that both the VE-PG4 and the connected devices or transceivers are turned OFF when connecting or disconnecting the cables.
- ① The default settings for the [EXT] ports are:
 [EXT1] / [EXT2]: To connect to a transceiver
 [EXT3] / [EXT4]: To connect to an external I/O port
 See the Section 6 for details on the [EXT] ports.

Panel description

■ Side and bottom panels

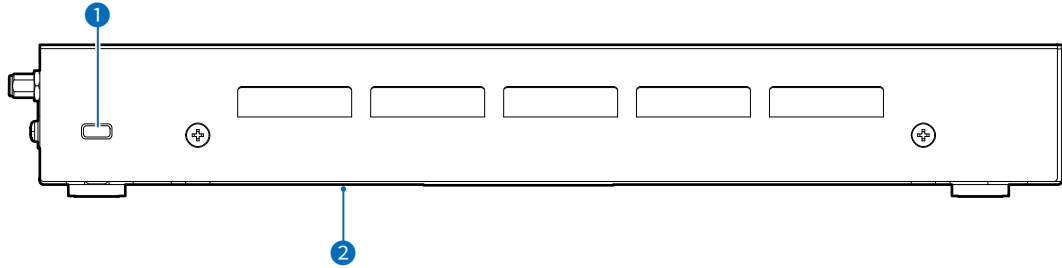

- 1 Security slot** Attach a security wire (user supplied). Refer to the instruction manual that comes with the security wire for details.
- 2 SIM card slot** Install the SIM card. Ask your dealer for installation or removal.

Feature description

■ Expanding communication coverage

You can communicate with Icom transceivers* through the communication port.

*Only the Icom recommended transceivers.

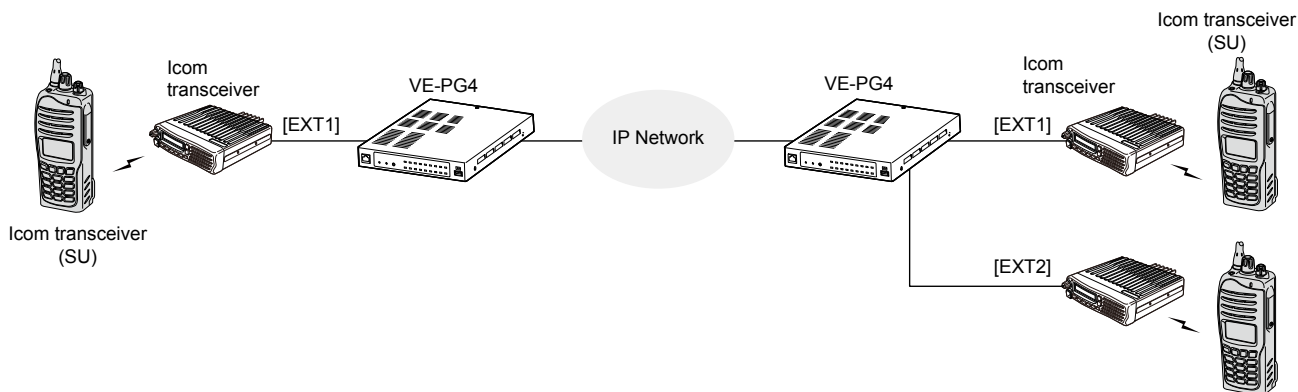

■ Communication between a VoIP telephone and a transceiver

• Up to 25 IP phones can be configured/registered as extensions.

• You can communicate between IP phone and a transceiver.

You can call a designated transceiver from the IP phone.

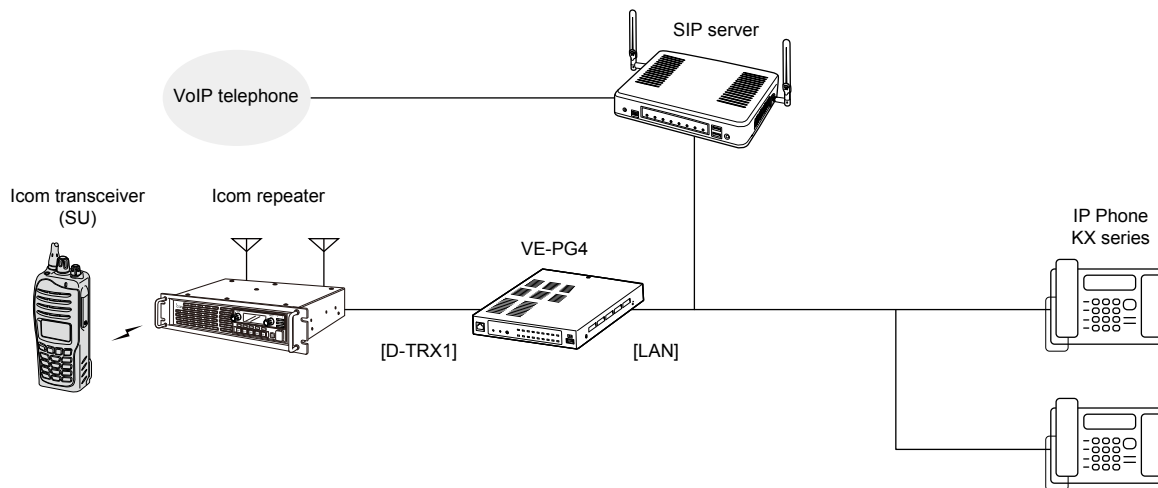

Feature description

■ Controlling wireless LAN transceivers

You can communicate through IP networks using the VE-PG4 as a controller for up to 50 wireless LAN transceivers.

- ① A wireless access point is required.
- ① The IP100H and IP100FS are usable, as of May, 2019.

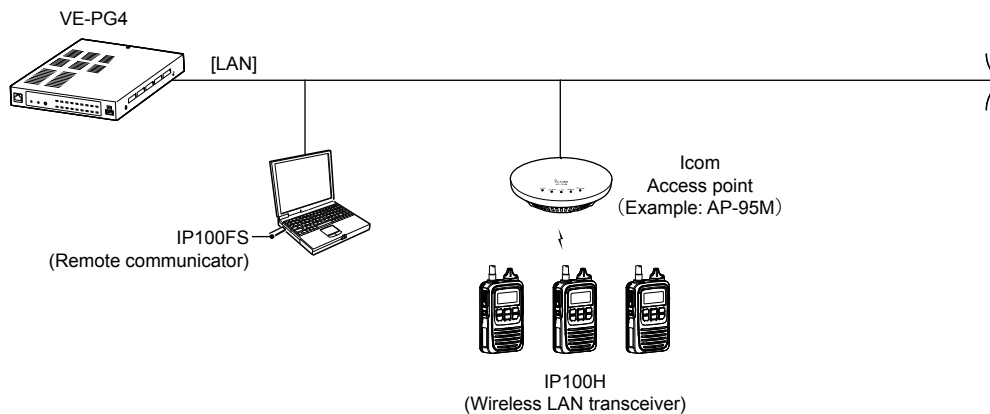

○ Simplex and Full-Duplex communication

The VE-PG4 has two methods of communication, Simplex and Full-Duplex.

Simplex is for communications where receive and transmit are done alternately one by one, and Full-Duplex is for simultaneous receive and transmit just like a telephone call.

Set the Communication Method in “Transceiver Settings” for each IP communication terminal registered to the VE-PG4.

- ① You have to connect an optional microphone to the IP100H to make Full-Duplex communications. You can communicate in the Simplex mode with no external microphone is connected.

○ All Call and Group Call

Simplex or Full-Duplex communication can be set for All Calls and Group Calls.

Enter a group on the Destination Setting screen, and then set a Group ID to each Wireless LAN transceiver to join a Group.

(Destination Settings > Destination Settings)

○ Area Call

To use Area Call, you must enable the [Area Call] for each IP100H on the Transceiver Settings screen, and then register the area's wireless access point (BSSID).

(Transceiver Controller > Transceiver Settings > Transceiver Settings > Function Settings > Area Call)

(Transceiver Controller > RoIP Server Settings > Area Call > Area Entry List)

Feature description

■ Controlling wireless LAN transceivers

○ Talkgroup

The Talkgroup Call function enables wireless LAN transceivers and IP transceivers to select the group that belong to it from previously registered groups in the VE-PG4.

When users select Talkgroup 1000, terminals are excluded from the original groups, as illustrated below.

When Talkgroup is OFF

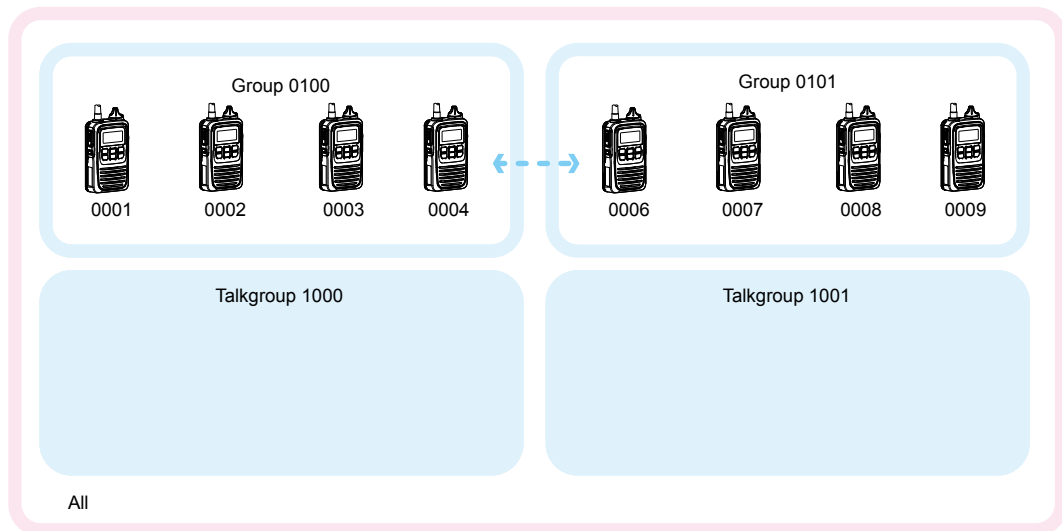

When Talkgroup is selected

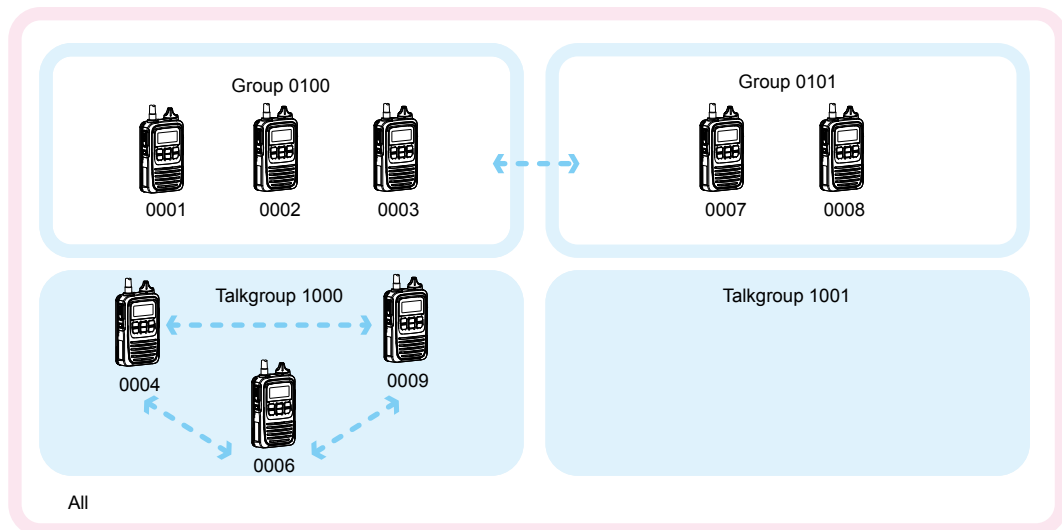

- Talkgroup Calls require registering the Talkgroups in the [Destination Settings] screen and [ID List] screen. If the "Talkgroup Type" in the [Destination Settings] screen is set to "Multiplex Talkgroup," a IP100H can make a Talkgroup Call between the linked Talkgroups.

(Transceiver Controller > Common Settings > ID List)

(Destination Settings > Destination Settings > Destination Settings > Talkgroup Type*)

*Displayed only when [Call Type] is set to "Talkgroup."

- Set to the VE-PG4 whether All Call includes the Talkgroup or not, or the Talkgroup Call calls the IP100FS or not.
- The ID List and the destination settings set in the VE-PG4 are commonly used in each group that the IP100H and IP100FS belong to.

Feature description

■ Connecting to the IP transceiver controllers

You can communicate between IP transceivers, wireless LAN transceivers, and conventional transceivers.

① When communicating through a 4G or 3G line, attach both antennas for the maximum performance.

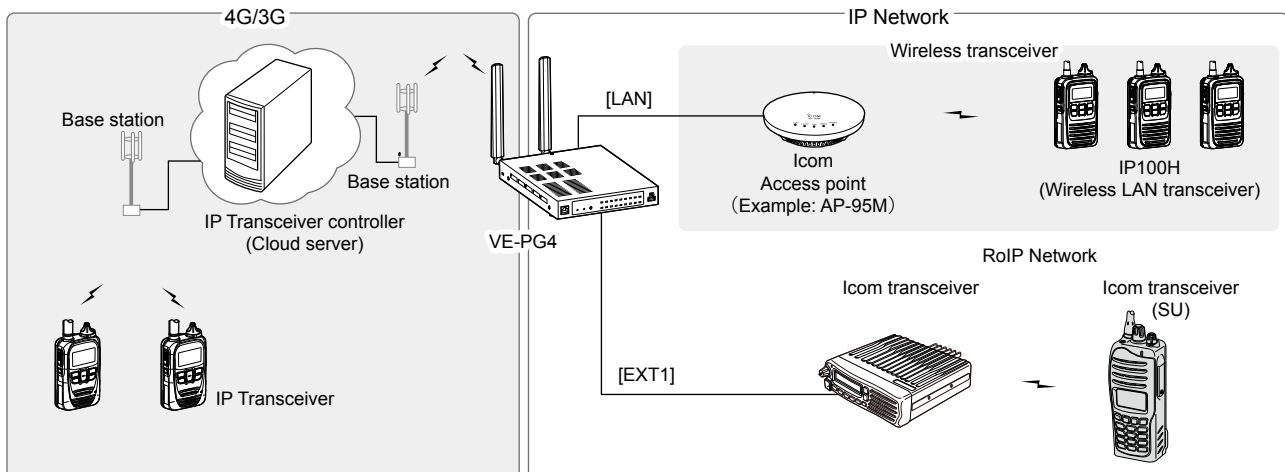

■ The router function

When the router function of the VE-PG4 is enabled, the devices such as PCs that are connected to the VE-PG4 can access the internet.

① The Routing function is disabled as the default.

① Ask your Internet service provider (ISP) for the network line type.

■ The VPN function

VPN (Virtual Private Network) enables a host computer to send and receive data across shared or public networks like the Internet as if it were a private network.

① Configure the VPN connection using the IPsec. (Refer to the advanced manual for details.)

① Connect the WAN line to the [WAN] port, and then configure the Router function to use the VPN function.

■ Audio recorder function

You can record the communication audio onto an external storage, through the USB port of the VE-PG4.

■ Virtual serial port

You can remotely control the VE-PG4 using a serial communication device.

Installation and connections

■ Attaching the magnet legs

You can the supplied 4 magnets on the bottom panel, and tighten the supplied screws to fix the magnet legs.

① Never use other than the supplied screws.

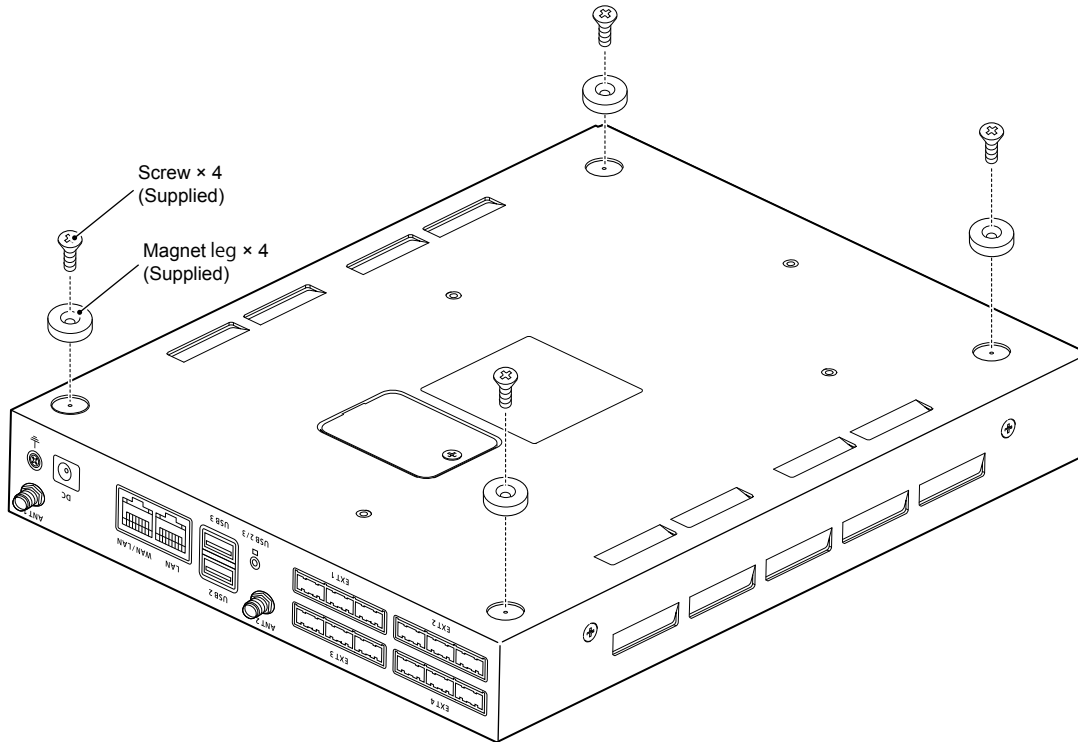

Installation and connections

■ Attaching the antennas

You have to attach the supplied antennas to control IP transceivers that communicate through a 4G or 3G line. These 2 antennas function as a diversity or MIMO that provides stable communication.

- Hold the bottom of antenna and turn it clockwise. Turn it counter clockwise to remove.
 - ① Attach both antennas for the maximum performance.
 - ② Adjust the angle or change the antenna location using a base mount for better performance.

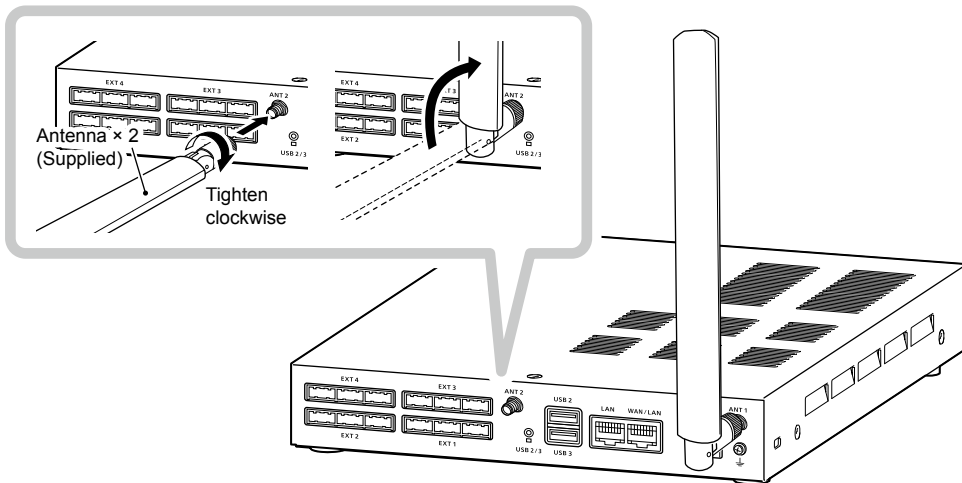

NOTE: Connecting to the antenna cable from a base mount

You can use the supplied extension cable (approximately 1.5 m (4.9 ft) length) to relocate the antenna, according to the installation location.

The base mount has a magnet on the bottom to securely attach on a metal place.

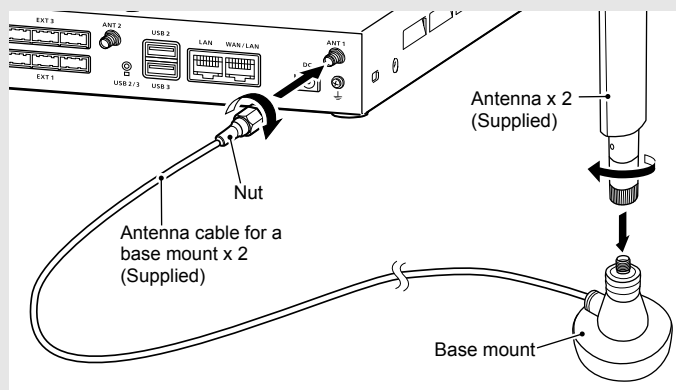

1 BEFORE USING THE VE-PG4

Installation and connections

■ Setting a static IP address to a PC

To access the VE-PG4 setting screen from a PC, set a static IP address to the PC.

① As the default for the VE-PG4, the IP address is set to “192.168.0.1,” and the DHCP server is set to “Disable.”

The following steps shows how to set a static IP address (example: 192.168.0.100), based on Microsoft Windows 10.

- 1 Click <Start> (Windows logo) and then click [Settings].
- 2 In “Windows settings” window, click [Change adapter options].
- 3 Right-click “Ethernet,” and then click “Properties” in the displayed menu list.

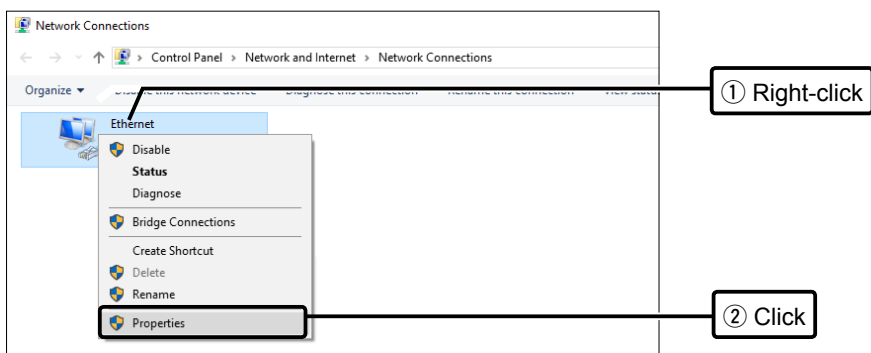

- 4 If the “User Account Control” message is displayed, click <Yes> to continue.
- 5 In the [Ethernet Properties] (for a cable LAN station) or the [WiFi Properties] (for a wireless LAN station) screen, select “Internet Protocol Version 4 (TCP/IPv4),” and then click <Properties>.
 - The “Internet Protocol Version 4 (TCP/IPv4) Properties” screen is displayed.

- 6 Select “Use the following IP address” and enter the IP address (example: 192.168.0.100) and the Subnet mask (example: 255.255.255.0), and then click <OK>.

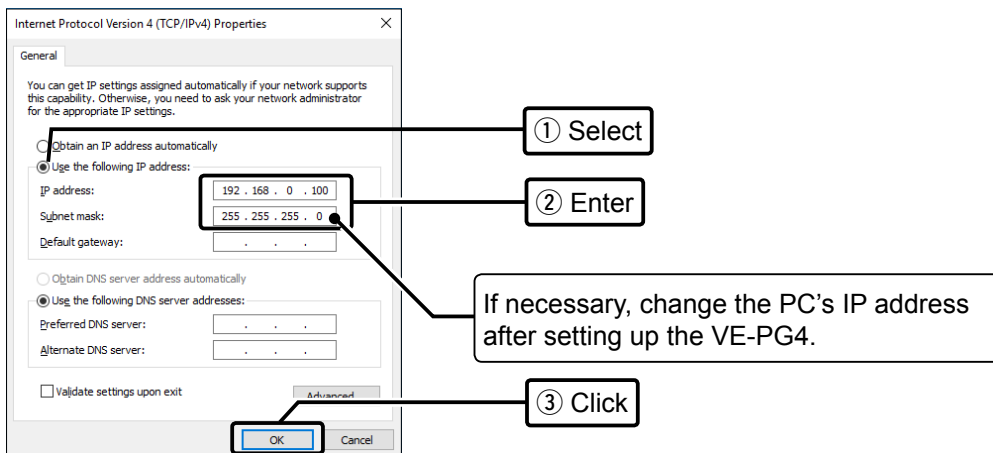

- 7 Close the window.

1 BEFORE USING THE VE-PG4

Installation and connections

■ Connecting the cables and the PC

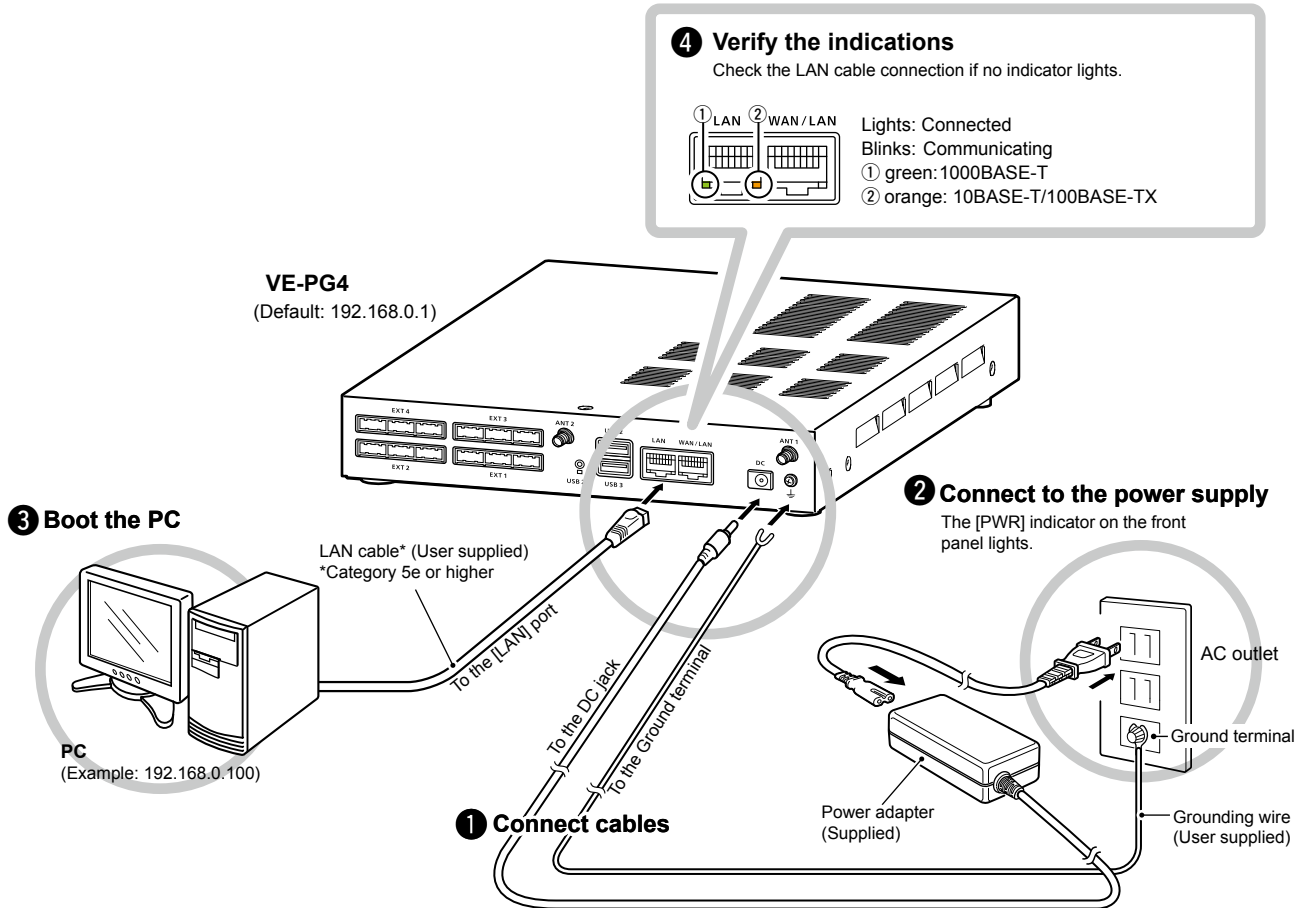

NOTE: Use the supplied clamp to fix the power cable to the ground terminal.

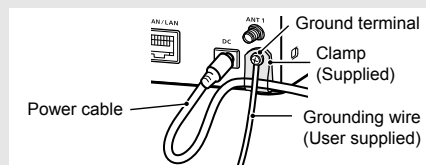

1 BEFORE USING THE VE-PG4

The setting screen

■ Accessing the setting screen

You can access the VE-PG4 setting screen with the web browser on your PC.

1 Open your Web browser.

2 Enter the IP address of the VE-PG4 into the address bar. (Default: 192.168.0.1)



3 Press the [Enter] key.

- The Login Authentication screen is displayed.

4 Enter “admin” (fixed username) and “admin” (default password) in their respective input fields in the Login Authentication window, and then click <OK>.

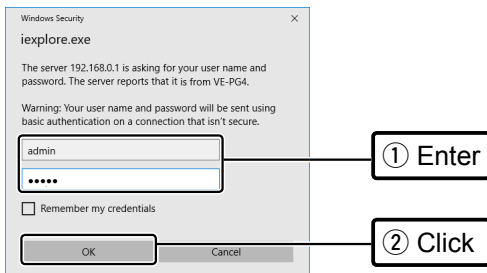

- The VE-PG4 Setting screen is displayed. (See the next page.)

About web browsers

- We recommend using Microsoft Internet Explorer 11 or later with the VE-PG4. The screen may not be correctly displayed on the other web browsers.
- Enable JavaScript® and set to accept cookies on your web browser to correctly display the setting screen.

The setting screen

Setting screen description

Refer to the Operating guide for each setting item details.

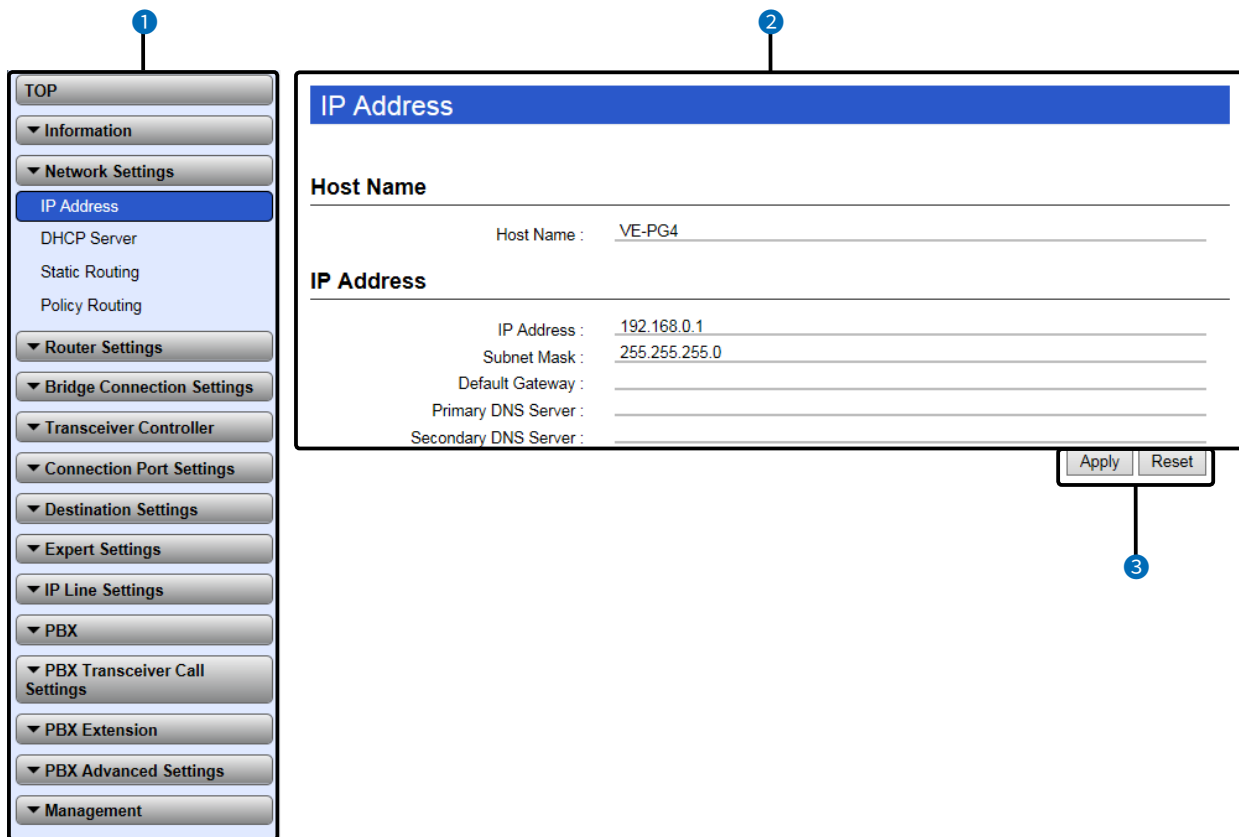

- 1 Menu list** Displays the list on a menu line. When you click each menu, a list of the submenu drops down so you can click to display the setting screen to the right.
- 2 Setting screen** Displays the settings and values when you click a submenu item to the left.
- 3 Button** Applies or resets the setting values.
 - The displayed buttons differ, depending on the screen.

NOTE: When the web browser window is not wide enough to display the whole width of the setting screen, the menu list will be hidden, and the menu icon will be displayed, as shown below. Click the icon to display the menu list.



1 BEFORE USING THE VE-PG4

The setting screen

■ Changing the IP address on the setting screen

Network Settings > IP Address > IP Address

① Make sure the VE-PG4's IP address does not conflict other network devices.

1 Click "Network Settings", and then click "IP Address".

2 In the "IP Address" screen, enter the new IP Address and then click <Apply>.

Host Name

Host Name : VE-PG4

IP Address

IP Address : 192.168.0.1

Subnet Mask : 255.255.255.0

Default Gateway : _____

Primary DNS Server : _____

Secondary DNS Server : _____

Apply

- The changes are saved.

3 Click <Back> to return to the previous page.

- The login menu is displayed.

4 Confirm the new IP address is displayed, and then login the VE-PG4 again.

IP Address assigning

An IP Address consists of two parts, the "Network" and "Host."

For example, in the VE-PG4's IP address "192.168.0.1" (Class C), the digits "192.168.0" are the network digits and the "1" at the end is the host digit.

Network devices with the same network numbers are recognized as belonging to the same network.

Furthermore, the network devices in the network are identified by the host part.

Assign the IP Address considering the following points.

- Set the identical network digits for all the devices that you want to add into the network.
- Do not set the same host digit to network devices in the same network.
- Do not set the network address whose the first digit of the host part is "0."
- Do not set the broadcast address whose the last digit of the host part is "255."

Transceiver system configuration	2-2
■ Installation Overview	2-2
Multicast mode operation	2-3
■ Registering a transceiver to the RoIP Gateway	2-3
■ Connecting a transceiver to the RoIP Gateway	2-6
■ Making a call	2-7
Unicast mode operation	2-8
■ Registering the transceiver to the RoIP Gateway	2-8
■ Connecting the transceiver to the RoIP Gateway	2-10
■ Making a call	2-10
NXDN Conventional mode operation	2-11
■ Setting up the UC-FR5000	2-11
■ Connecting to a digital radio through the network	2-12
■ Setting for the transceivers	2-13
■ Connecting the transceiver to the RoIP Gateway	2-16
■ Making a call	2-17
Settings for the IP transceivers	2-18
Connecting the speaker microphone	2-20
Recording the transceiver communication audio	2-22
■ The Recording settings	2-22
■ About the recorded files	2-23
Connecting the Satellite PTT	2-24

Transceiver system configuration

■ Installation Overview

The following shows a typical procedure for connecting the transceivers to the VE-PG4.

- 1 **Preparing requirements** (p.iii)
You may need purchase the appropriate optional cables for your transceiver.
- 2 **Setting the transceivers**
Before connecting to a transceiver to the RoIP Gateway, make the individual transceiver settings, such as the channels, audio volume, and so on.
① Check the manual for your transceivers for details on the settings.
- 3 **Registering the transceivers to the VE-PG4** (pp.2-3, 2-8, 2-13)
Access the setting screen of the VE-PG4, and register the transceivers that you want to connect to it.
① Configure the functions, depending on your transceiver system configuration.
- 4 **Connecting the transceivers to the VE-PG4** (pp.2-6, 2-10, 2-16)
Connect the transceivers to the ports using the optional cables or LAN cables.

NOTE: Turn OFF the RoIP Gateway and the transceivers before connecting.

Usable repeaters and transceivers for the VE-PG4 (As of May, 2019)

The usable transceiver models may differ, depending on the country or your transceiver system environment. Ask your dealer for details.

Repeaters:

Type	Model	Interface	Mode
IDAS	IC-FR5000*/IC-FR6000*	LAN (Ethernet)	NXDN Type-D (Conventional/Multi-site Conventional Single-site Trunking/Multi-site Trunking)
dPMR	IC-FR5000*/IC-FR6000*	LAN (Ethernet)	dPMR Mode2

*The optional UC-FR5000 must be installed.

Transceivers:

Type	Model	Interface	Mode
LMR	IC-F5060/IC-F6060	EXT1 ~ 4	Analog
Aviation	IC-A120	EXT1 ~ 4	Analog
Marine	IC-M604A/IC-M605	EXT1 ~ 4	Analog
Satellite PTT	IC-SAT100	EXT1 ~ 4	Analog

Multicast mode operation

Connection Port Settings > EXT I/O (EXT)

Bridge Connection Settings > Bridge Connection

In the Multicast mode, a call from one site can be sent to multiple sites. This instruction is an example of the setting to communicate between the transceivers (A1 and B1) in the simplex mode:

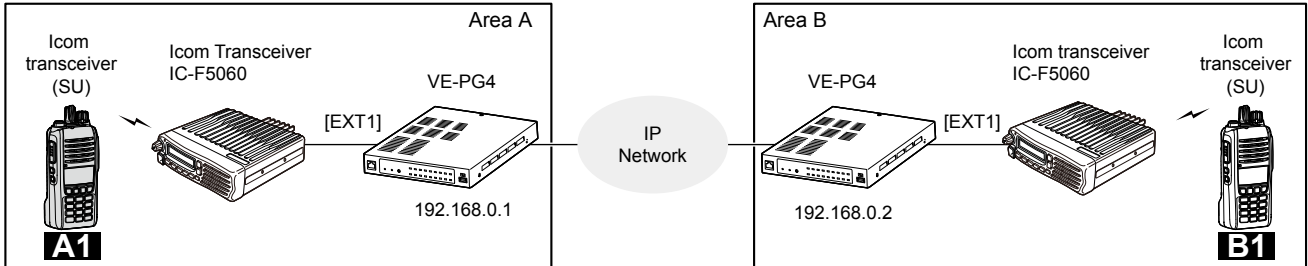

■ Registering a transceiver to the RoIP Gateway

- 1 Open the EXT I/O (EXT) screen.
(Connection Port Settings > EXT I/O (EXT))
- 2 In [EXT I/O Port Mode], confirm “Connected Unit” for EXT I/O1 (EXT1) is set to “Transceiver.”

EXT I/O Port Mode	
EXT I/O1 (EXT1)	Connected Unit : <input type="text" value="Transceiver"/> Confirm
EXT I/O2 (EXT2)	Connected Unit : <input type="text" value="Transceiver"/>
EXT I/O3 (EXT3)	Connected Unit : <input type="text" value="EXT I/O Unit"/>
EXT I/O Port Mode :	<input type="text" value="Combined"/>

- 3 Confirm the EXT I/O Port is set to “EXT I/O 1 (EXT1),” Select “IC-F5060/F6060” in “Transceiver Model,” and then click <Apply>.

EXT I/O	
EXT I/O Port :	<input type="text" value="EXT I/O1 (EXT1)"/> ① Confirm
Transceiver Model	
Transceiver Model :	<input type="text" value="IC-F5060/F6060"/> ② Select
<small>Remove the transceiver from the main unit before changing this setting. All the settings on this page will be initialized if you change this setting.</small>	
	<input type="button" value="Apply"/> ③ Click

① When connecting another transceiver model, select the appropriate model name.

2 SETTING UP THE TRANSCEIVERS

Multicast mode operation

■ Registering a transceiver to the RoIP Gateway

- 1 Open the Bridge Connection screen.
(Bridge Connection Settings > Bridge Connection)
- 2 In [Bridge Connection], confirm the connection Source (Example: EXT1), the Bridge Connection Destination (Custom Bridge Connection), and the IP address of the destination (239.255.255.1), then click <Apply>.

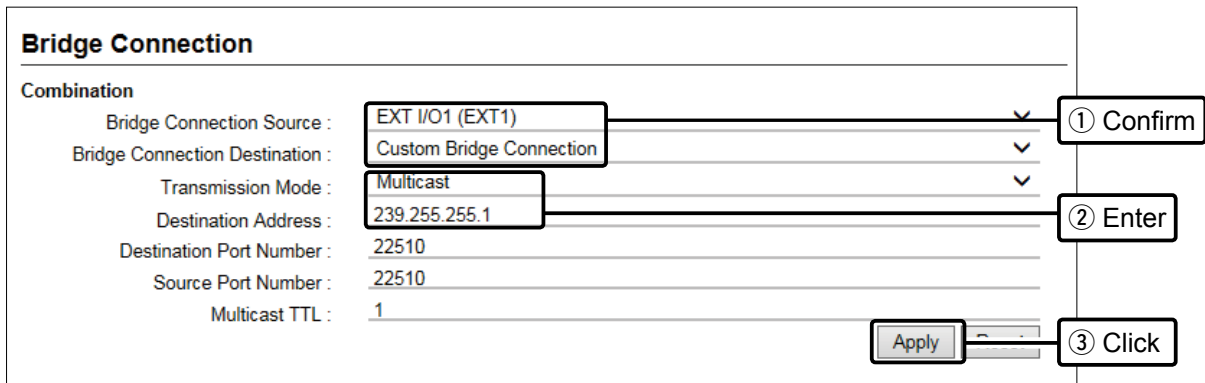

Bridge Connection

Combination

Bridge Connection Source : EXT I/O1 (EXT1) ① Confirm

Bridge Connection Destination : Custom Bridge Connection

Transmission Mode : Multicast

Destination Address : 239.255.255.1 ② Enter

Destination Port Number : 22510

Source Port Number : 22510

Multicast TTL : 1

Apply ③ Click

• The confirmation dialogs are displayed. Click <OK> twice to apply them.

① When the bridge connection is set, the Connection Port setting is deleted from the “Destination Settings” (Destination settings > Destination Settings)

- 3 In [AMBE+2 Vocoder Assignment], select the Voice Protocol and AMBE+2 Vocoder Assignment, and then click <Apply>.

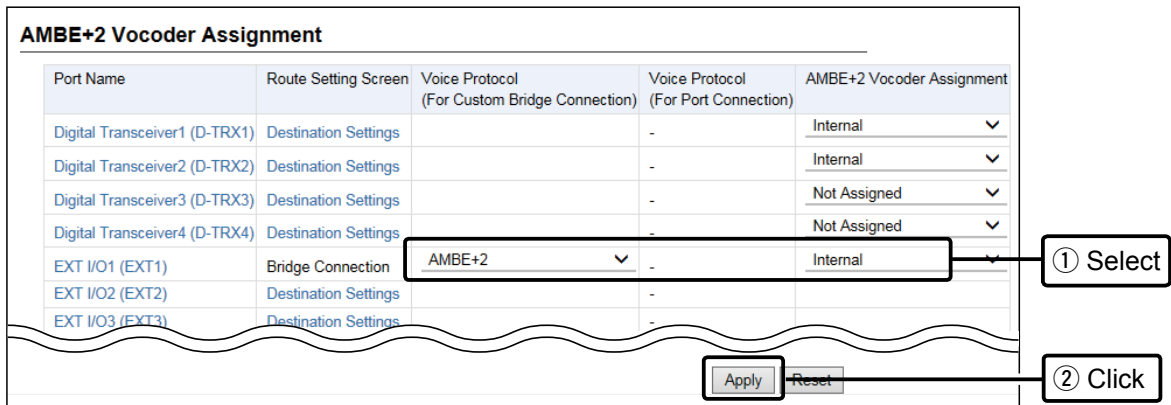

AMBE+2 Vocoder Assignment

Port Name	Route Setting Screen	Voice Protocol (For Custom Bridge Connection)	Voice Protocol (For Port Connection)	AMBE+2 Vocoder Assignment
Digital Transceiver1 (D-TRX1)	Destination Settings		-	Internal
Digital Transceiver2 (D-TRX2)	Destination Settings		-	Internal
Digital Transceiver3 (D-TRX3)	Destination Settings		-	Not Assigned
Digital Transceiver4 (D-TRX4)	Destination Settings		-	Not Assigned
EXT I/O1 (EXT1)	Bridge Connection	AMBE+2	-	Internal
EXT I/O2 (EXT2)	Destination Settings		-	
EXT I/O3 (EXT3)	Destination Settings		-	

Apply ② Click

① By default, all of the 4 Internal AMBE+2 vocoders are assigned to the digital transceivers. Disable one of the internal AMBE+2 vocoders to assign it to the EXT1 port.

② If you need an additional AMBE+2 vocoder, an optional CT-24 DIGITAL VOICE CONVERTER is required.

Multicast mode operation

■ Registering a transceiver to the RoIP Gateway

- 4 In [Bridge Connection Entry List (For Custom Bridge Connection)], click <Activate>. Confirm the “Connection Status” has changed to “Active.”

Bridge Connection Entry List (For Custom Bridge Connection)

Bridge Connection Source	Transmission Mode	Destination Address	Port Number		Connection Status	Refresh
			Destination	Source		
EXT I/O1 (EXT1)	Multicast	239.255.255.1	22510	22510	Inactive	Activate

① Click

Delete All



Bridge Connection Entry List (For Custom Bridge Connection)

Bridge Connection Source	Transmission Mode	Destination Address	Port Number		Connection Status	Refresh
			Destination	Source		
EXT I/O1 (EXT1)	Multicast	239.255.255.1	22510	22510	Active	

② Confirm

Delete All

Multicast mode operation

■ Connecting a transceiver to the RoIP Gateway

- 1 Set the transceiver channel, volume level, TX output power, and other necessary settings, before connecting to the RoIP Gateway.

NOTE: Turn OFF both the RoIP Gateway and the transceiver before connecting the cable.

- 2 Connect the RoIP Gateway and the transceiver, using the appropriate optional cable.

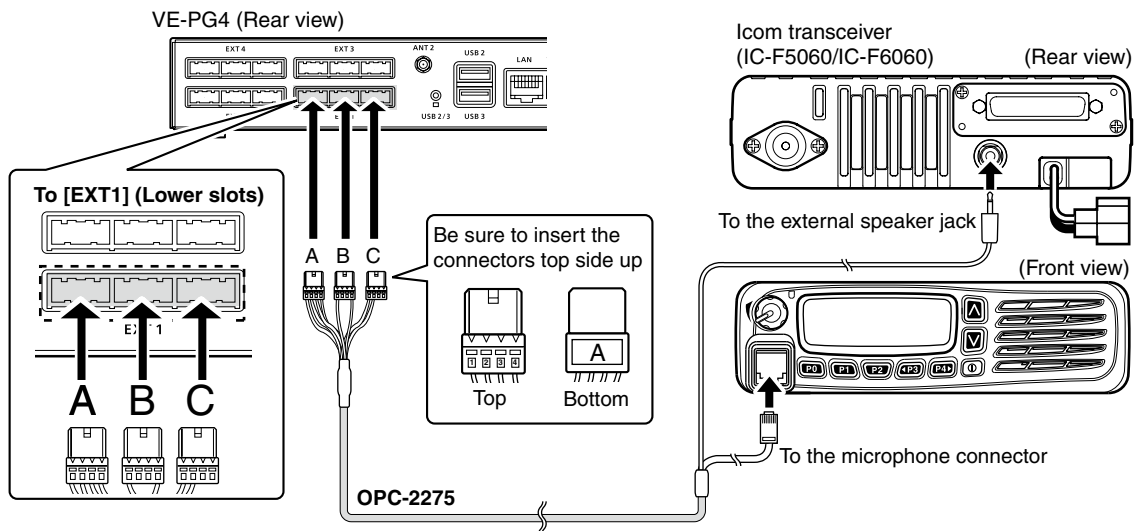

① The [EXT1] and [EXT2] ports (lower slots) accept transceivers, by default.

- 3 Turn ON the transceiver and the RoIP Gateway.

NOTE:

- Turn OFF both the radio and the RoIP Gateway when connecting or disconnecting the transceiver.
- Keep the radio away from a PC, a power adapter and other electronic equipment. The noise emitted from those equipment may interfere with the radio.
- When operating the radio, do not transmit near the IP telephone.

2 SETTING UP THE TRANSCEIVERS

Multicast mode operation

■ Making a call

Set the same settings to all the client transceivers in the same area as the transceiver that is connected to the RoIP gateway (Example: IC-F5060).

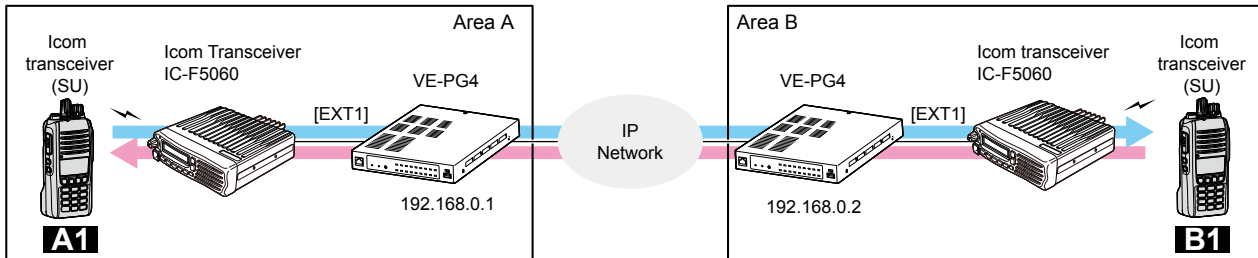

In Area A

1. While holding down [PTT], speak at your normal voice level.
 - The transceiver A1 transmits to the transceiver in Area B.
2. Release [PTT] to receive.

In Area B

3. While holding down [PTT], speak at your normal voice level.
 - The transceiver B1 answers the call from Area A.
4. Release [PTT] to receive.

Unicast mode operation

Connection Port Settings > EXT I/O (EXT)

Bridge Connection Settings > Bridge Connection

In the Unicast mode, you can call the designated radio, through a communication port. This instruction is the example of the setting to communicate between the transceivers (A1 and B1) in the simplex mode:

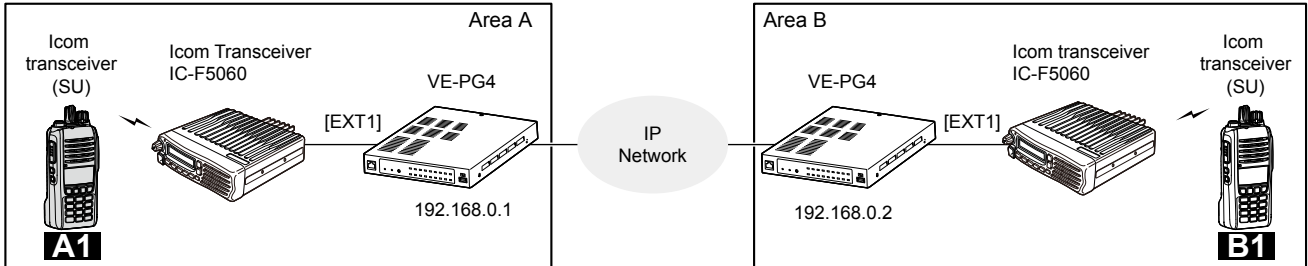

■ Registering the transceiver to the RoIP Gateway

- 1 Open the EXT I/O (EXT) screen.
(Connection Port Settings > EXT I/O (EXT))
- 2 In [EXT I/O Port Mode], confirm “Connected Unit” for EXT I/O1 (EXT1) is set to “Transceiver.”

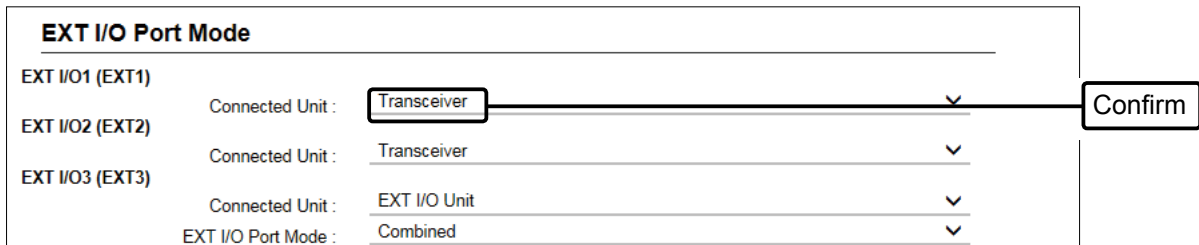

- 3 Confirm the EXT I/O Port is set to “EXT I/O 1 (EXT1),” Select “IC-F5060/F6060” in Transceiver Model, and then click <Apply>.

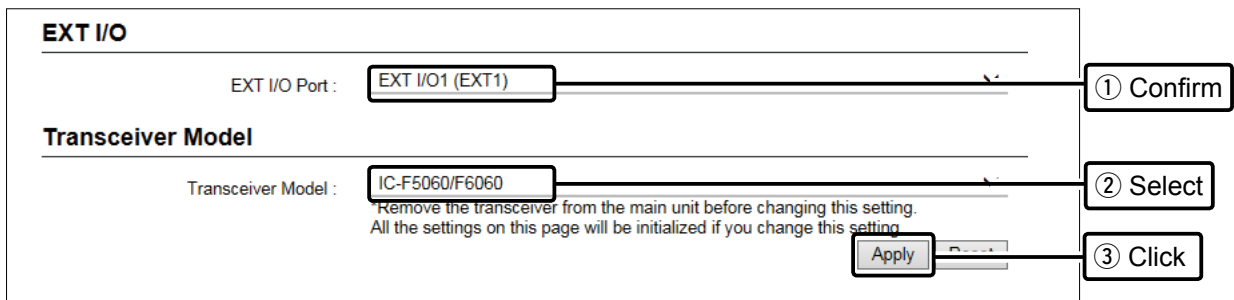

① When connecting another transceiver model, select appropriate model name.

Unicast mode operation

■ Registering the transceiver to the RoIP Gateway

- 4 Open the Bridge Connection screen.
(Bridge Connection Settings > Bridge Connection)
- 5 In [Bridge Connection], set the connection Source (Example: EXT1), the Bridge Connection Destination (Custom Bridge Connection), and the IP address of the destination (Example: VE-PG4 in Area B (192.168.0.2)), then click <Apply>.

Bridge Connection

Combination

Bridge Connection Source : EXT I/O1 (EXT1) ① Confirm

Bridge Connection Destination : Custom Bridge Connection ⌵

Transmission Mode : Unicast ⌵

Destination Address : 192.168.0.2 ② Enter

Destination Port Number : 23100

Source Port Number : 23100

Apply ③ Click

- The confirmation dialogs are displayed. Click <OK> twice to apply them.

① When the bridge connection is set, the Connection Port setting is deleted from the "Destination Settings."
(Destination settings > Destination Settings)

- 6 In [AMBE+2 Vocoder Assignment], set the Voice Protocol and AMBE+2 Vocoder Assignment, and then click <Apply>.

AMBE+2 Vocoder Assignment

Port Name	Route Setting Screen	Voice Protocol (For Custom Bridge Connection)	Voice Protocol (For Port Connection)	AMBE+2 Vocoder Assignment
Digital Transceiver1 (D-TRX1)	Destination Settings		-	Internal ⌵
Digital Transceiver2 (D-TRX2)	Destination Settings		-	Internal ⌵
Digital Transceiver3 (D-TRX3)	Destination Settings		-	Not Assigned ⌵
Digital Transceiver4 (D-TRX4)	Destination Settings		-	Not Assigned ⌵
EXT I/O1 (EXT1)	Bridge Connection	AMBE+2 ⌵	-	Internal ⌵
EXT I/O2 (EXT2)	Destination Settings		-	
EXT I/O3 (EXT3)	Destination Settings		-	

Apply Reset ② Click

① At default, all of the 4 Internal AMBE+2 vocoders are assigned to the digital transceivers. Disable one of the internal AMBE+2 vocoder to assign it to the EXT1 port.

① If you need an additional AMBE+2 vocoder, an optional CT-24 DIGITAL VOICE CONVERTER is required.

Unicast mode operation

■ Connecting the transceiver to the RoIP Gateway

- 7 In [Bridge Connection Entry List (For Custom Bridge Connection)], click <Activate>. Confirm the “Connection Status” is changed to “Active.”

The image shows two screenshots of the 'Bridge Connection Entry List (For Custom Bridge Connection)' interface, connected by a downward arrow. The top screenshot shows a table with one entry: 'EXT I/O1 (EXT1)' with 'Unicast' transmission mode, destination address '192.168.0.2', and port numbers '23100' for both destination and source. The 'Connection Status' is 'Inactive'. A box highlights the 'Activate' button, with a callout '① Click'. The bottom screenshot shows the same entry with 'Multicast' transmission mode, destination address '239.255.255.1', and port numbers '22510' for both destination and source. The 'Connection Status' is now 'Active'. A box highlights the 'Active' status, with a callout '② Confirm'. Both screenshots include 'Refresh' and 'Delete All' buttons.

Bridge Connection Source	Transmission Mode	Destination Address	Port Number		Connection Status	
			Destination	Source		
EXT I/O1 (EXT1)	Unicast	192.168.0.2	23100	23100	Inactive	Activate

↓

Bridge Connection Source	Transmission Mode	Destination Address	Port Number		Connection Status	
			Destination	Source		
EXT I/O1 (EXT1)	Multicast	239.255.255.1	22510	22510	Active	

■ Connecting the transceiver to the RoIP Gateway

Refer to “Connecting the transceiver to the RoIP Gateway” in Operating in Multicast mode, described former in this section.

■ Making a call

Refer to “Making a call” in Operating in Multicast mode, described former in this section.

NXDN Conventional mode operation

The IC-FR5000 series can be connected with the VE-PG4 via Ethernet cable (IP network) using the UC-FR5000 NETWORK BOARD.

- In the instruction, the example of the communication as illustrated below, is used.
- Prepare an optional CT-24 DIGITAL VOICE CONVERTER, if required.

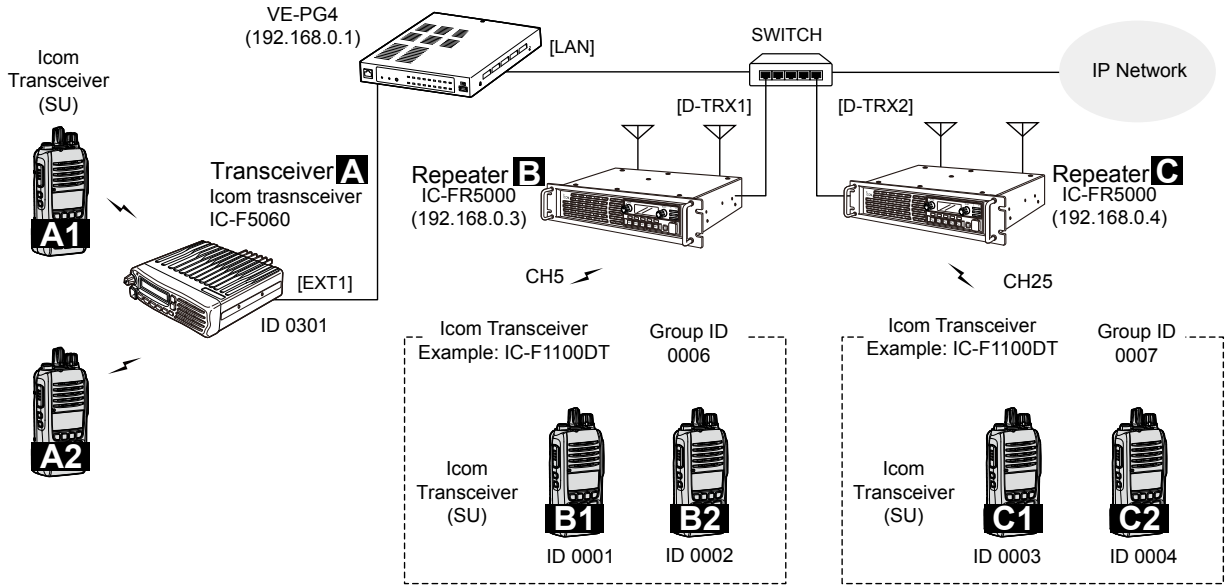

Setting up the UC-FR5000

- 1 Access the UC-FR5000 setting screen of the Repeater B, and set the items as shown below.

Operation Mode Select

Conventional

Single-site Trunking

Multi-site Trunking

Select

Remote Dispatch Settings

Service

Remote Dispatch Disable Enable ① Select

Connectable Console List

No.	IP Address / Host name / Domain name	Comments
1	192.168.0.1	VE-PG4
2		
3		

② Enter

Port Setting

Connection Receive Port Default 41200 ③ Enter

Data Receive Port Default 41220

Connect Key

Key Code ④ Enter

- 2 Connect the Repeater B to the network.

NXDN Conventional mode operation

Connection Port Settings > Digital Transceiver (D-TRX)

■ Connecting to a digital radio through the network

Connect a digital radio to the VE-PG4 through the network, and set in [Digital Transceiver Connection].

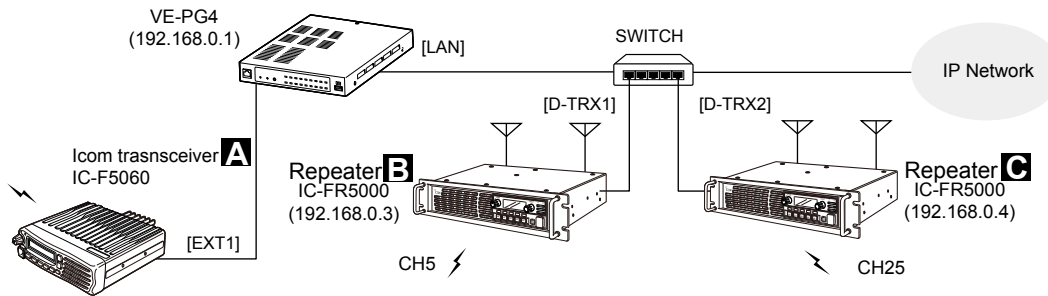

- 1 Open the Digital Transceiver (D-TRX) screen.
(Connection Port Settings > Digital Transceiver (D-TRX))
- 2 In [Digital Transceiver], select a port (example: D-TRX1), in [Digital Transceiver System], select a system (example: NXDN Conventional), and then click <Apply>.

Digital Transceiver

Port Selection : Digital Transceiver1 (D-TRX1) ① Select

Digital Transceiver System

System : NXDN Conventional ② Select

Each setting is initialized after changing.

Apply
Reset
③ Click

- 3 Enter the settings for the Repeater B (example: IC-FR5000), such as the IP address, Port Number, and Connection Key Code.

Digital Transceiver Connection

Connected Repeater's Address : 192.168.0.3

TCP Port Number (Connection Port) : 41200

UDP Port Number (Data Port) : 41220

Connection Key Code : ucfr5000 Enter

Packet Encryption

Digital Frame Packet : Disable Enable

Unit

Unit ID : 1

Talkgroup

Talkgroup ID : 1

RAN

- 4 Click <Apply>.
- 5 In Digital Transceiver Connection, click <Connect> to connect to the Repeater B.
 - “Connecting” is displayed when the RoIP Gateway is successfully connected.
- 6 Set up the Repeater C as the same way.

(☞ Continued on the next page)

NXDN Conventional mode operation

Setting for the transceivers

Set up the connection and destination settings on the RoIP Gateway setting screen.

① The Group ID 0006 and 0007 are for the Group Call regardless of the repeater that the client transceivers belong to.

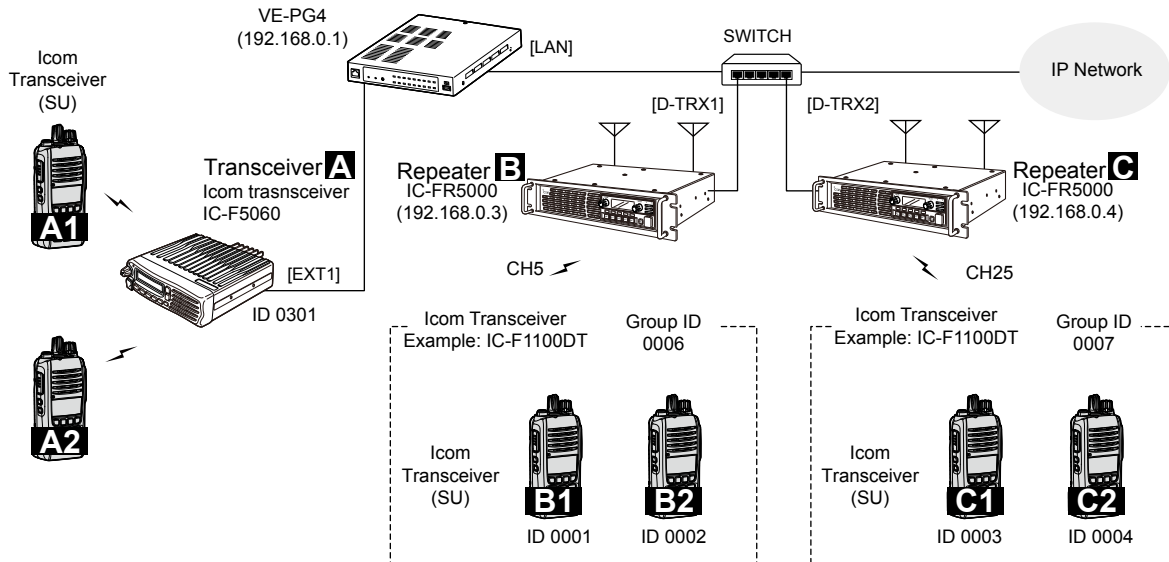

	Setting screen	Setting item	Setting name	Value
Repeater B	Bridge Connection > Bridge connection	AMBE+2 Vocoder Assignment	AMBE+2 Vocoder Assignment	Digital Transceiver1 (D-TRX1): Internal
		AMBE+2 Vocoder Assignment	AMBE+2 Vocoder Assignment	Digital Transceiver1 (D-TRX2): Internal
Transceiver A	Connection Port Settings > EXT I/O (EXT)	EXT I/O Port Mode	EXT I/O1 (EXT1)	Transceiver
		Transceiver Model	Transceiver Model	IC-F5060/6060
	Destination Settings > Destination Settings	Destination Settings	Call Type	Individual
		Destination Settings	Destination ID	0301
Transceiver B1	Destination Settings > Destination Settings	Destination Settings	Connection Port	EXT I/O1 (EXT1)
			Call Type	Individual
			Destination ID	0001
Transceiver B2	Destination Settings > Destination Settings	Destination Settings	Connection Port	Digital Transceiver1 (D-TRX1)
			Call Type	Individual
			Destination ID	0002
Transceiver C1	Destination Settings > Destination Settings	Destination Settings	Connection Port	Digital Transceiver1 (D-TRX1)
			Call Type	Individual
			Destination ID	0003
Transceiver C2	Destination Settings > Destination Settings	Destination Settings	Connection Port	Digital Transceiver2 (D-TRX2)
			Call Type	Individual
			Destination ID	0004
Group 0006	Destination Settings > Destination Settings	Destination Settings	Connection Port	Digital Transceiver2 (D-TRX2)
			Call Type	Group
			Destination ID	0006
Group 0007	Destination Settings > Destination Settings	Destination Settings	Connection Port	Digital Transceiver1 (D-TRX1) and Digital Transceiver2 (D-TRX2)
			Call Type	Group
			Destination ID	0007
			Connection Port	Digital Transceiver1 (D-TRX1) and Digital Transceiver2 (D-TRX2)

2 SETTING UP THE TRANSCEIVERS

NXDN Conventional mode operation

Destination Settings > Destination Settings

■ Setting for the transceivers

- 1 Open the Destination Settings screen.
(Destination Settings > Destination Settings)
- 2 In [Destination Settings], enter the setting for the transceiver B1 (Name, Call Type, Destination ID, and Additional Controller/IP Transceiver Controller/Connection Port), and then click <Apply>.

The screenshot shows the 'Destination Settings' form for transceiver B1. The fields are: No.: 1, Name: Transceiver B1, Call Type: Individual, Destination ID: 0001, and Additional Controller/IP Transceiver Controller/Connection Port: Digital Transceiver1 (D-TRX1). A box highlights the Name, Call Type, and Destination ID fields, with an arrow pointing to a circled '1' and the word 'Enter'. Another box highlights the 'Apply' button, with an arrow pointing to a circled '2' and the word 'Click'.

- 3 Add the transceiver B2, C1, C2 as the same way.
- 4 In [Destination Settings], enter the setting for the Group 0006 (Name, Call Type, Destination ID, and Connection Port), and then click <Apply>.

The screenshot shows the 'Destination Settings' form for Group 0006. The fields are: No.: 13, Name: Transceiver B, Call Type: Group, Destination ID: 0006, and Group Priority: Normal. The Communication Type is set to Full-Duplex. Under 'WLAN Transceivers', 'All' is selected. Under 'Additional Controller', 'None' is selected. Under 'IP Transceiver Controller/Connection Port', 'Digital Transceiver1 (D-TRX1)' and 'Digital Transceiver2 (D-TRX2)' are selected. A box highlights the Name, Call Type, and Destination ID fields, with an arrow pointing to a circled '1' and the word 'Enter'. Another box highlights the selected transceiver options, with an arrow pointing to a circled '2' and the word 'Select'. A third box highlights the 'Apply' button, with an arrow pointing to a circled '3' and the word 'Click'. A callout box says: 'Check when you want to call to Group 0006 from the transceiver C1 or C2'.

- 5 Add the Group 0007 as the same way.

2 SETTING UP THE TRANSCEIVERS

NXDN Conventional mode operation

■ Setting for the transceivers

- 6 Confirm the entries in [List of Destination Setting Entries (Group Call)] and [List of Destination Setting Entries (Individual Call)].

List of Destination Setting Entries (Group Call)

<input type="checkbox"/> All	No.	Name	Destination ID	Group Priority	Number of WLAN Transceivers	Additional Controller	IP Transceiver Controller/Connection Port	Edit	Delete
<input type="checkbox"/>	6	Transceiver B	0006	Normal	-	Not Set	Set	Edit	Delete
<input type="checkbox"/>	7	Transceiver C	0007	Normal	-	Not Set	Set	Edit	Delete

① Confirm

List of Destination Setting Entries (Individual Call)

<input type="checkbox"/> All	No.	Name	Destination ID	Additional Controller/IP Transceiver Controller/Connection Port	Edit	Delete
<input type="checkbox"/>	1	Transceiver B1	0001	Digital Transceiver1 (D-TRX1)	Edit	Delete
<input type="checkbox"/>	2	Transceiver B2	0002	Digital Transceiver1 (D-TRX1)	Edit	Delete
<input type="checkbox"/>	3	Transceiver C1	0003	Digital Transceiver2 (D-TRX2)	Edit	Delete
<input type="checkbox"/>	4	Transceiver C2	0004	Digital Transceiver2 (D-TRX2)	Edit	Delete
<input type="checkbox"/>	1970	Digital Transceiver1 (D-TRX1)	0201	Digital Transceiver1 (D-TRX1)	Edit	Delete
<input type="checkbox"/>	1971	Digital Transceiver2 (D-TRX2)	0202	Digital Transceiver2 (D-TRX2)	Edit	Delete
<input type="checkbox"/>	1972	Digital Transceiver3 (D-TRX3)	0203	Digital Transceiver3 (D-TRX3)	Edit	Delete
<input type="checkbox"/>	1973	Digital Transceiver4 (D-TRX4)	0204	Digital Transceiver4 (D-TRX4)	Edit	Delete
<input type="checkbox"/>	1974	EXT Input1 (EXT1)	0351	-	Edit	Delete
<input type="checkbox"/>	1975	EXT Output1 (EXT1)	0301	EXT I/O1 (EXT1)	Edit	Delete
<input type="checkbox"/>	1976	EXT Input2 (EXT2)	0352	-	Edit	Delete

② Confirm

③ Confirm

(☞ Continued on the next page)

NXDN Conventional mode operation

■ Connecting the transceiver to the RoIP Gateway

- 1 Set the transceiver channel, volume level, TX output power, and other necessary settings, before connecting to the RoIP Gateway.

NOTE: Turn OFF both the RoIP Gateway and the transceiver before connecting the cable.

- 2 Connect the RoIP Gateway and the transceiver, using the appropriate optional cable.

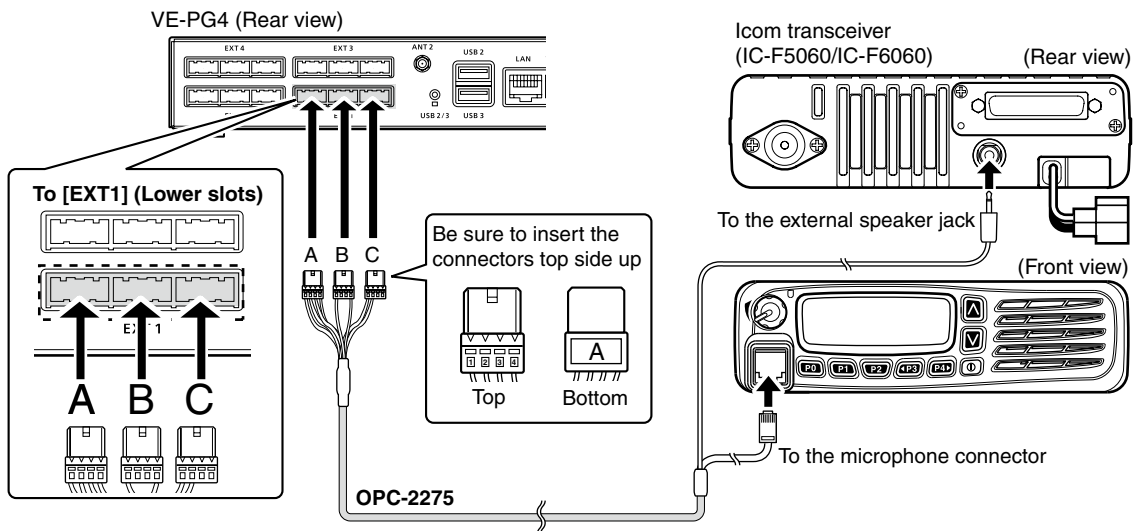

① The [EXT1] and [EXT2] ports (lower slots) accept transceivers, by default.

- 3 Turn ON the transceiver and the RoIP Gateway.

NOTE:

- Turn OFF both the radio and the RoIP Gateway when connecting or disconnecting the transceiver.
- Keep the radio away from a PC, AC adapter and other electronic equipment. The noise emitted from those equipment may interfere with the radio.
- When operating the radio, do not transmit near the IP telephone.

NOTE: 4 Internal AMBE+2 vocoders can be assigned to the digital transceivers. If you need an additional AMBE+2 vocoder, an optional CT-24 DIGITAL VOICE CONVERTER is required.

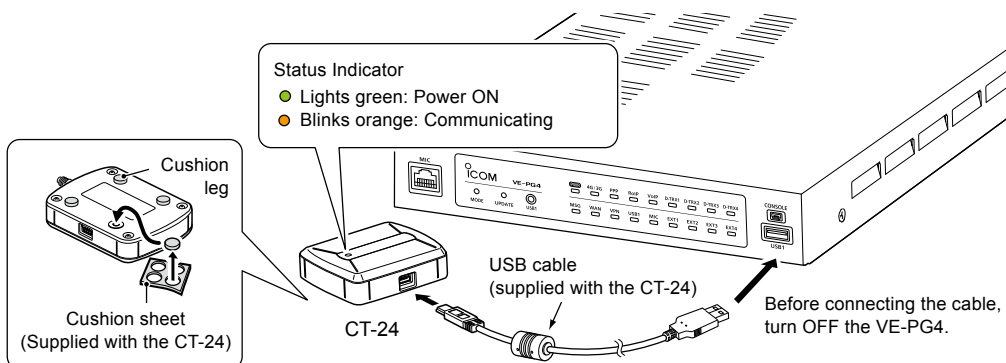

NXDN Conventional mode operation

■ Making a call

- ① Set the same settings (such as Tone settings) for each client transceivers as the settings in the RoIP Gateway.
- ① This instructions assume as that the client transceiver settings have been completed.

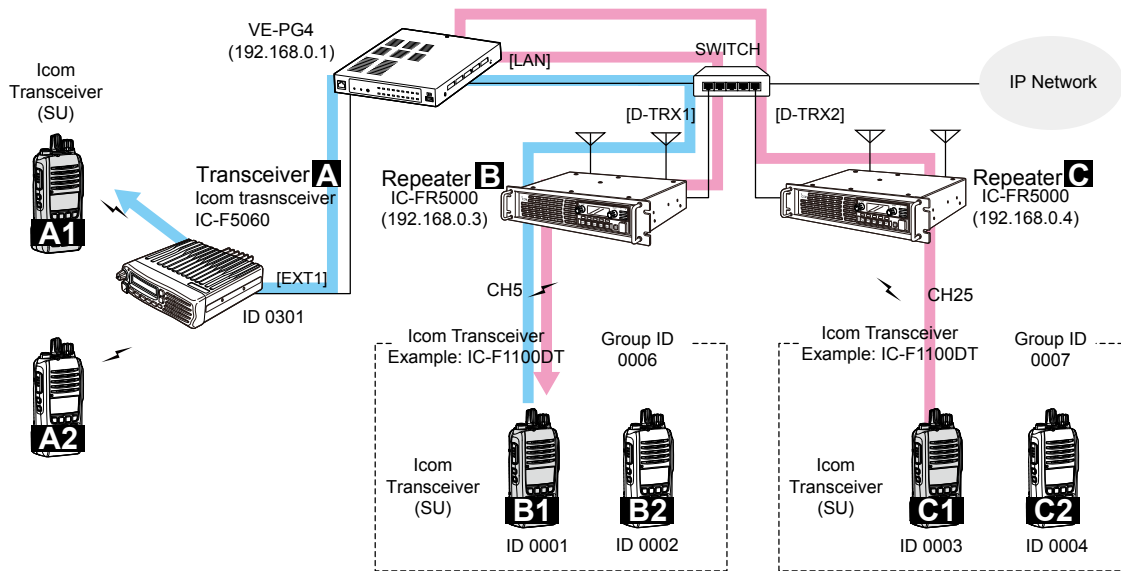

Making a call from Transceiver B1 to A1 and A2

(With the transceiver B1)

1. Select the destination ID of the A1 (A2) (example: 0301).
2. Push [PTT], and speak at your normal voice level.
3. Release [PTT] to receive.

(With the transceiver A1 or A2)

4. Push [PTT] to answer.
5. Release [PTT] to receive.

Making a call from Transceiver C1 to B1

(With the transceiver C1)

1. Select the destination ID of the B1 (example: 0001).
 ① If you want to call to the Group 0006, select 0006.
2. Push [PTT] and speak at your normal voice level.
3. Release [PTT] to receive.

(With the transceiver B1)

4. Push [PTT] to answer.
5. Release [PTT] to receive.

Making a call from Transceiver A1 to B1

Setting on the setting screen

1. Open the EXT I/O (EXT) screen. (Connection Port Settings > EXT I/O (EXT))
2. In [EXT I/O Port], select a port (example: EXT I/O1 (EXT1)).
3. In [Bridge Communication], set Call Type to "Individual," Destination ID to "0001", and Prefix ID (if necessary), and then click <Apply>.

Operation

(With the Transceiver A1)

1. Push [PTT], and speak at your normal voice level.
2. Release [PTT] to receive.

(With the Transceiver B1)

3. Push [PTT] to answer.
4. Release [PTT] to receive.

Settings for the IP transceivers

Destination Settings > Destination Settings

When the SIM card is attached to the RoIP Gateway, you can connect to it to an IP transceiver controller. The illustration below shows an example for communicating between 2 IP transceivers and the VE-PG4 network.

The settings for the transceiver A, see “Unicast mode operation” in this section.

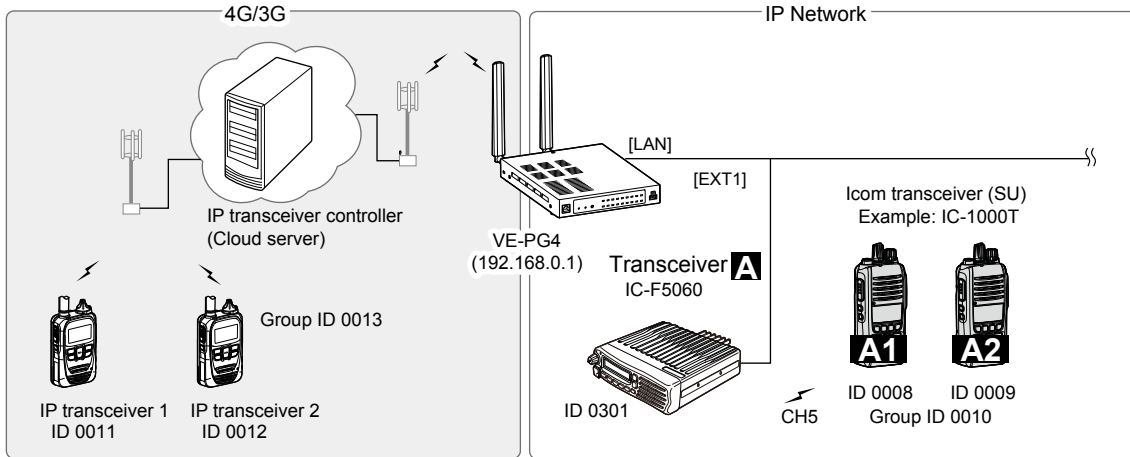

1 Open the Destination Settings screen.
(Destination Settings > Destination Settings)

2 In [Destination Settings], enter the settings for the IP transceiver 1 (Name, Call Type, Destination ID, and IP Transceiver Controller), and then click <Apply>.

The screenshot shows the 'Destination Settings' screen. The fields are as follows:

- No.: 11
- Name: IP Transceiver 1
- Call Type: Individual
- Destination ID: 0011
- Additional Controller/IP Transceiver Controller/Connection Port: IP Transceiver Controller

Annotations on the screen indicate: ① Enter (pointing to the Name field) and ② Click (pointing to the Apply button).

3 Add the IP transceiver 2 as the same way.

2 SETTING UP THE TRANSCEIVERS

Settings for the IP transceivers

Destination Settings > Destination Settings

- 4 In [Destination Settings], enter the settings for the Group 0013 (Name, Call Type, Destination ID, and Connection Port), and then click <Apply>.

Destination Settings

No. : 13

Name : IP Transceivers

Call Type : Group

Destination ID : 0013

Group Priority : Normal High

Destination

Communication Type : Simplex Full-Duplex

WLAN Transceivers

All 0101(Sales1) 0102(Sales2) 0103(Sales3) 0050(IP100FS)

Additional Controller : None

IP Transceiver Controller/Connection Port

All IP Transceiver Controller

Digital Transceiver1 (D-TRX1) Digital Transceiver2 (D-TRX2) Digital Transceiver3 (D-TRX3)

Digital Transceiver4 (D-TRX4)

EXT I/O1 (EXT1) EXT I/O2 (EXT2) EXT I/O3 (EXT3) EXT I/O4 (EXT4)

Emergency Notification

Microphone (MIC)

RoIP Gateway1 RoIP Gateway2 RoIP Gateway3

RoIP Gateway4 RoIP Gateway5 RoIP Gateway6 RoIP Gateway7 RoIP Gateway8

Apply Reset

① Enter

② Select

Check when you want to call to transceiver Group (0010) from the IP transceiver 1 or 2

③ Click

- 5 Confirm the entered destination settings in [List of Destination Setting Entries (Group Call)] or [List of Destination Setting Entries (Individual Call)].

List of Destination Setting Entries (Group Call)

<input type="checkbox"/> All	No.	Name	Destination ID	Group Priority	Number of WLAN Transceivers	Additional Controller	IP Transceiver Controller/Connection Port		
<input type="checkbox"/>	6	Transceiver B	0006	Normal	-	Not Set	Set	Edit	Delete
<input type="checkbox"/>	7	Transceiver C	0007	Normal	-	Not Set	Set	Edit	Delete
<input type="checkbox"/>	13	IP Transceivers	0013	Normal	-	Not Set	Set	Edit	Delete

Delete Selected Delete All

① Confirm

List of Destination Setting Entries (Individual Call)

<input type="checkbox"/> All	No.	Name	Destination ID	Additional Controller/IP Transceiver Controller/Connection Port		
<input type="checkbox"/>	1	Transceiver B1	0001	Digital Transceiver1 (D-TRX1)	Edit	Delete
<input type="checkbox"/>	2	Transceiver B2	0002	Digital Transceiver1 (D-TRX1)	Edit	Delete
<input type="checkbox"/>	3	Transceiver C1	0003	Digital Transceiver2 (D-TRX2)	Edit	Delete
<input type="checkbox"/>	4	Transceiver C2	0004	Digital Transceiver2 (D-TRX2)	Edit	Delete
<input type="checkbox"/>	11	IP Transceiver 1	0011	IP Transceiver Controller	Edit	Delete
<input type="checkbox"/>	12	IP Transceiver 2	0012	IP Transceiver Controller	Edit	Delete
<input type="checkbox"/>	1970	Digital Transceiver1 (D-TRX1)	0201	Digital Transceiver1 (D-TRX1)	Edit	Delete

② Confirm

Connecting the speaker microphone

Connection Port Settings > Microphone (MIC)

Destination Settings > Destination Settings

The following illustration shows an example for connecting the optional HM-241 SPEAKER MICROPHONE (Future product) to the VE-PG4.

① Either of the [MIC] port on the front panel or [EXT1] port on the rear panel. When a speaker microphone is connected to the [MIC] port, the [EXT1] port is disabled.

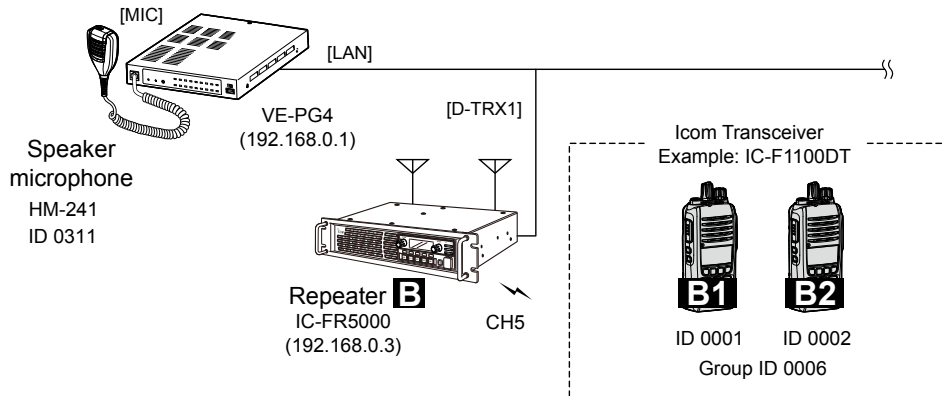

1 Open the Microphone (MIC) screen.
(Connection Port Settings > Microphone (MIC))

2 In [Bridge Communication], enter the call type, destination prefix ID (if required), and destination ID that you want to call from the speaker microphone, and then confirm the own ID of the microphone is set.

Bridge Communication

Encryption : Disable Enable

TalkBack : Disable Enable

TalkBack Time : 5 seconds

Default Callee ID

Call Type : Group Enter

Destination Prefix ID : _____

Destination ID : 0006

Source ID : 0311

Enter the same setting as the Destination ID for the "Microphone (MIC)" in [List of Destination Setting Entries (Individual Call)]

3 In [Voice Output Control], enter the output gain and the notice tone volume, and then click <Apply>.

Voice Output Control

Voice Volume

Output Gain : +40 dB ① Enter

Notice Tone Volume : +30 dB

Apply ② Click

Connecting the speaker microphone

Connection Port Settings > Microphone (MIC)

Destination Settings > Destination Settings

- 4 Open the Destination Settings screen.
(Destination Settings > Destination Settings)
- 5 In [Destination Settings], add a check mark to “Microphone (MIC)” in “IP Transceiver Controller/Connection Port” to the setting of that you want to call using the microphone, and then click <Apply>.

The screenshot shows the 'Destination Settings' configuration page. At the top, there are fields for 'No.' (6), 'Name' (Transceivers B), 'Call Type' (Group), and 'Destination ID' (0006). Below these are radio buttons for 'Group Priority' (Normal selected) and 'Communication Type' (Full-Duplex selected). There are two expandable sections: 'WLAN Transceivers' and 'IP Transceiver Controller/Connection Port'. The 'IP Transceiver Controller/Connection Port' section is highlighted with a black box and contains several checkboxes, including 'Microphone (MIC)' which is checked. An annotation box with a circled '1' and the text 'Select' points to this section. Another annotation box with the text 'Check when you want to call to transceiver Group (0006) from the microphone' points to the 'Microphone (MIC)' checkbox. At the bottom right, there are 'Apply' and 'Reset' buttons, with an annotation box with a circled '2' and the text 'Click' pointing to the 'Apply' button.

Destination Settings

No. : 6
Name : Transceivers B
Call Type : Group
Destination ID : 0006
Group Priority : Normal High
Communication Type : Simplex Full-Duplex

Destination

WLAN Transceivers
 All 0101(Sales1) 0102(Sales2) 0103(Sales3) 0050(IP100FS)

Additional Controller : None

IP Transceiver Controller/Connection Port

All Digital Transceiver1 (D-TRX1) Digital Transceiver2 (D-TRX2) Digital Transceiver3 (D-TRX3)
 Digital Transceiver4 (D-TRX4)
 EXT I/O1 (EXT1) EXT I/O2 (EXT2) EXT I/O3 (EXT3) EXT Input4 (EXT4)
 EXT Output4 (EXT4)
 Emergency Notification
 Microphone (MIC)
 RoIP Gateway1 RoIP Gateway4 RoIP Gateway5 RoIP Gateway6 RoIP Gateway7
 RoIP Gateway8

Apply Reset

① Select

Check when you want to call to transceiver Group (0006) from the microphone

② Click

Recording the transceiver communication audio

You can record the communication audio between the transceivers to an external storage device that is connected to the USB port of the RoIP Gateway.

You can enter up to 4 recording boxes. To each recording box, you can set conditions to be recorded, such as the type of call or the target (Unit ID or Group ID).

① You cannot record the calls as follows:

- Between IP phones
- Between IP phone and IP transceivers
- Direct communication between digital transceivers
- Communication through a bridge connection

② The recording stops after detecting a mute for the set period of time. (Default: 5 seconds)

③ A data transmission while recording is recorded as a mute.

Expert Settings > Call Recording

The Recording settings

(Example: recording All Calls to the Box 1)

1 Open the Call Recording screen.
(Expert Settings > Call Recording)

2 In [Recorder Setting], select Mode (Example: Recording) and Call Type (Example: All), and then click <Apply>.

Common Setting

Silence Recording : Disable Enable

Silence Period to End Recording : seconds

Overwriting the Oldest Files : Disable Enable

Recorder Setting

Index :

Mode : ① Select

Target : Disable Enable

Call Type : ② Select

③ Click

① When you select "Monitor," in the Mode setting, the RoIP Gateway outputs the audio to the specified port. Refer to the Operating guide for details.

3 Confirm the settings in [List of Recording Box Entries].

List of Recording Box Entries

Index	Mode	Unit ID	Call Type	Call ID	Destination Address	Destination Port Number	Source Port Number
1	Recording	-	All	-	-	-	-
2	Monitor + Recording	-	Group	103	192.168.0.10	25002	25002
3	Disable	-	-	-	-	-	-
4	Disable	-	-	-	-	-	-

Recording the transceiver communication audio

■ About the recorded files

On the external storage device, a folder for each recording box is created, and the recorded audio is saved to a file (.wav) in the folder.

The file name for each call type:

Record type		File name format	Example (10:12:34 on April 10, 2019)
Recording Box (Folder)		voice_data[Box No.] > [date](yyyymmdd)	voice_data1\20190410
File (.wav)	All call	mmdd_hhmmss_all	0410_101234_all.wav
	Group call	mmdd_hhmmss_group[partner's Group ID]	0410_101234_group100.wav (Group call from/to Group100)
	Individual call	mmdd_hhmmss_uid[partner's Unit ID]	0410_101234_uid10.wav (Individual call from/to Unit ID 10)
	Telephone call	mmdd_hhmmss_tel[partner's Extension]	0410_101234_tel31.wav (Telephone call from/to Extension 31)

Information

- The maximum size of a file is 100 MB. An additional file is created for the data exceeding 100 MB.
- You can set whether or not to overwrite old data with new data when the folder is full.
If you accept overwriting, the older files are deleted to secure at least 110 MB of free space in the folder.
- New audio will not be recorded until sufficient free space is secured in the folder.

Connecting the Satellite PTT

The following is an example of connecting the RoIP Gateway and Satellite PTTs (IC-SAT100), that enables you to make a call between an IP transceiver and a client Satellite PTT.

- The IC-SAT100 connected to the RoIP Gateway is required to be assigned a fixed unique group ID.
- Enter only one fixed Talkgroup to the IC-SAT100. If you want to use the Emergency Call function, connect another IC-SAT100 to the [EXT] port for the emergency calls.

Example: Talkgroup 1 (for usual calls): Uses the Satellite PTT A on the [EXT1] port.
 Talkgroup 2 (for emergency calls): Uses the Satellite PTT B on the [EXT2] port.

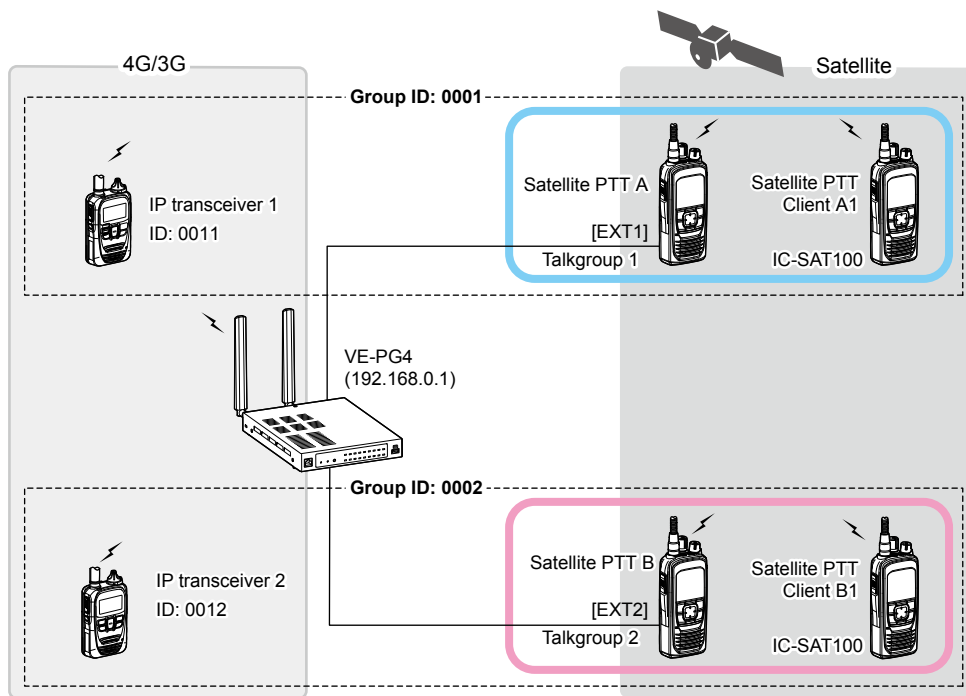

Before connecting the IC-SAT100 to the RoIP Gateway:

- On the IC-SAT100, select "Multi-Connector" in the PC Command setting. ([OK] > Function > PC Command)
- In the RoIP Gateway, select "IC-SAT100" in the Transceiver Model setting for the EXT port that you want to connect the IC-SAT100 to. (Connection Port Settings > EXT I/O (EXT) > Transceiver Model)

NOTE:

- The transceiver receives and transmits using several satellites following the same orbit. Receiving and transmitting may fail, depending on the satellite position or any obstacles between the transceiver and the satellites.
- Be sure to set up the IC-SAT100 that is connected to the RoIP Gateway with the OPC-2412 CONNECTION CABLE (length: 5 m (16.4 ft)) in a place where it can receive and transmit from/to the satellites.

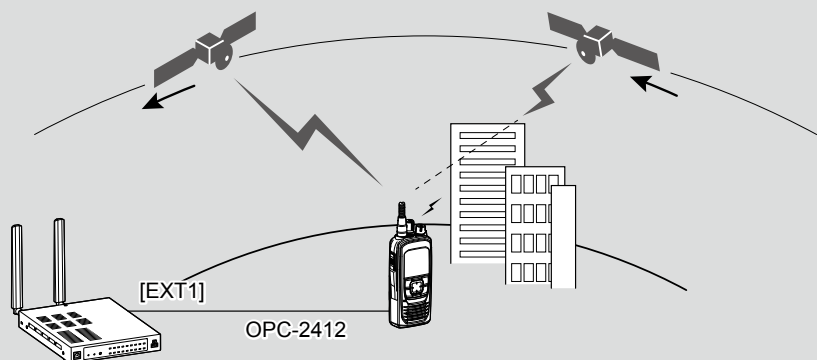

Before using the wireless LAN transceiver controller.....	3-2
■ Installation overview	3-2
Configuring the wireless LAN transceiver system	3-4
■ Connecting to wireless LAN transceivers	3-4
■ Registering the wireless LAN transceivers	3-5
■ Checking the IP100H settings	3-6
■ The Transceiver Settings	3-7
■ The Group Call	3-8
■ The Talkgroup Call	3-9
■ The ID List	3-11
■ The Messages	3-12
■ The Status	3-13
■ Setting the common ID List and Messages in the group	3-14

Before using the wireless LAN transceiver controller

■ Installation overview

The following shows a typical setting procedure for the wireless LAN transceiver controller on the VE-PG4 Setting screen.

1 Network Settings > IP Address

Enter the IP address according to your network environment. (Default: 192.168.0.1)

Network Settings > DHCP Server

Enable or disable the VE-PG4's DHCP server function. (Default: Disable)

2 Transceiver Controller > Transceiver settings > Transceiver Registration

Transceiver Controller > Common Settings

Enter the Transceiver Model, Name and Unit ID, Password and Setting group.

① The default password is "iptr". You can change it for security.

① Customize the common settings for the transceiver group (Tenant) on the Common Settings screen.

Setting by the CS-IP100H CLONING SOFTWARE

After IP100Hs are registered to the RoIP Gateway, set the wireless LAN settings, antenna settings (internal or external), provisioning server settings (RoIP Gateway) for all the IP100Hs.

① The CS-IP100H CLONING SOFTWARE can be downloaded from the Icom website. Refer to the IP100H instructions for details.

3 Transceiver Controller > Transceiver settings > Transceiver settings

Set the functions, such as Communication Method (Simplex or Full-Duplex), Priority Call, Area Call, Message, and Status, for each transceiver.

Enable the required functions for all the IP100Hs that are registered on the Transceiver Registration screen.

- Use ID list
- Priority Call
- Message
- Communication Method (Simplex/Full-duplex)
- Area Call
- Status

4 Destination Settings > Destination Settings

Assign the registered IP100Hs or IP100FS on the Transceiver Registration screen to a group. The group ID and the communication type are set on the Destination Settings screen.

NOTE: Applying the settings to the IP100H

If the RoIP Gateway's setup has been changed, be sure to restart the IP100H to apply the setting.

Before using the wireless LAN transceiver controller

■ Installation overview

5 **Transceiver Controller > Common Settings**

Set the common settings of each group that the IP100Hs or IP100FSs belong to, and are registered on the Transceiver Registration screen.

ID List screen

Register the unit IDs that are registered on the Transceiver Registration screen, or the group IDs that are registered on the Destination Settings screen.

- ① When an RoIP Gateway's bridge connection is made with the RoIP Gateway, you can register the telephone number of the IP phone.

Message screen

Enter up to 10 messages that the IP100H will send.

- ① Up to 32 characters can be entered for each message.

Status screen

Enter up to 10 statuses that the IP100H will send.

- ① Up to 32 characters can be entered for each status.

Profile screen

Select the ID list and message list of the group that the IP100H belongs to.

6 Customize the settings if required.

Transceiver Controller > Transceiver settings > Transceiver settings

Setting for the microphone gain, VOX function, or headset. (When an optional microphone is connected)

Transceiver Controller > Common Settings > Profile

Setting for the Ringers and Talkback timer.

Configuring the wireless LAN transceiver system

■ Connecting to wireless LAN transceivers

Up to 50 of the total IP100H and IP100FS can register to the RoIP Gateway.

The following illustration is an example of setting requirements to register an IP100H to an RoIP Gateway.

- Each terminal requires that you set the unit ID and so on.
- Connect a wireless access point to the RoIP Gateway network.
- In this manual, it is assumed that the IP address of PCs using IP100H or IP100FS is automatically obtained from the DHCP server in the same network as the RoIP gateway.
- When assigning static IP addresses to the terminals, make sure that the addresses of the devices on the network don't overlap or conflict.

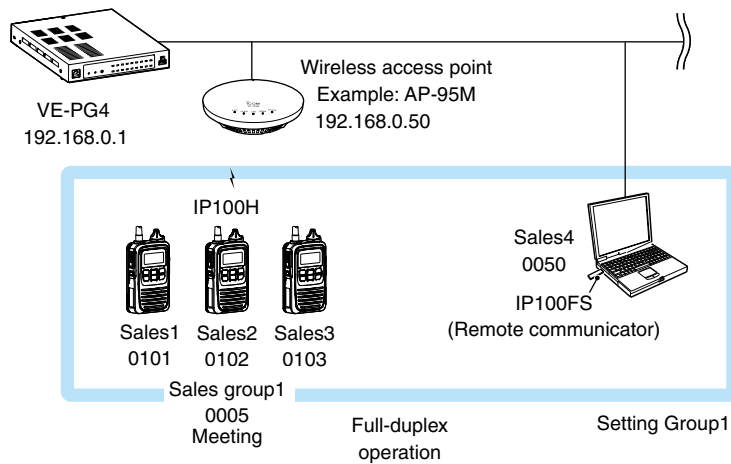

Configuring the wireless LAN transceiver system

■ Registering the wireless LAN transceivers

Register a wireless LAN transceiver to the RoIP Gateway.

- 1 Open the Transceiver Registration screen.
(Transceiver Controller > Transceiver Settings > Transceiver Registration)
- 2 In the [Transceiver Settings], enter the Transceiver Model, Name, and Unit ID (4 digit), and then click <Add>.

Transceiver Settings

TRX No. : 1

Transceiver Model : IP100H

Name : Sales 1

Unit ID : 0101

Security Password : iptrx

Connection Port Transceiver Port Number : 30000

Server Port Number : 30000

Profile Profile : 1

Buttons: Add, Reset

Annotations:

- ① Enter: Points to the Name and Unit ID fields.
- ② Click: Points to the Add button.
- The Profile ID that is entered on the Profile screen: Points to the Profile dropdown menu.

① Click <OK> if a confirmation message is displayed.

- 3 In Transceiver Setting Entry List screen, confirm the entry.

Transceiver Setting Entry List

<input type="checkbox"/>	TRX No.	Transceiver Model	Name	Unit ID	Password	Connection Port Transceiver	Server	Profile	ID List	Message List
<input type="checkbox"/>	1	IP100H	Sales1	0101	iptrx	30000	30000	1	1	1 (\$
<input type="checkbox"/>	2	IP100H	Sales2	0102	iptrx	30002	30002	1	1	1 (\$
<input type="checkbox"/>	3	IP100H	Sales3	0103	iptrx	30004	30004	1	1	1 (\$
<input type="checkbox"/>	50	IP100FS	IP100FS	0050	iptrx		30098	1	1	1 (\$

Buttons: Apply, Reset, Delete Selected, Delete All

Annotation: Confirm: Points to the first row of the table.

Using TRX Batch Setting

You can register 2 or more transceivers at once in sequential TRX numbering, or copy the settings from an already entered wireless LAN transceiver settings. Enter the range of TRX numbers that you want to copy to, select the TRX number of the original, and then click <Add>.

TRX Batch Setting

Range : _____ - _____

Refer to : Default

Profile : 1

Buttons: Add, Reset

Annotations:

- ① Enter: Points to the Range input field.
- ② Click: Points to the Add button.

Configuring the wireless LAN transceiver system

■ Checking the IP100H settings

After registering the IP100H to the RoIP Gateway, enter the required settings of the IP100H on the PC, using the CS-IP100H cloning software.

After the settings on the CS-IP100H have been applied to the IP100H, restart the IP100H to connect to the RoIP Gateway to receive the settings from it.

When the IP100H settings are successfully completed, the IP100H displays the standby screen.

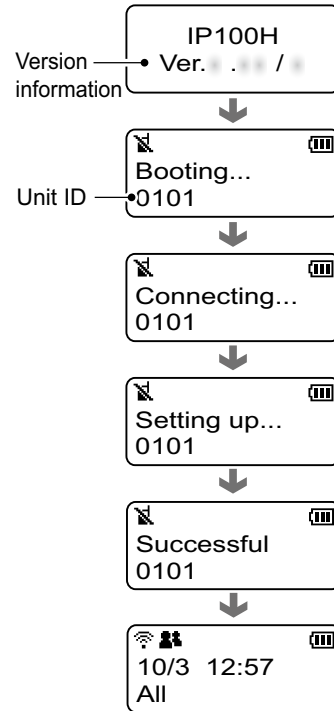
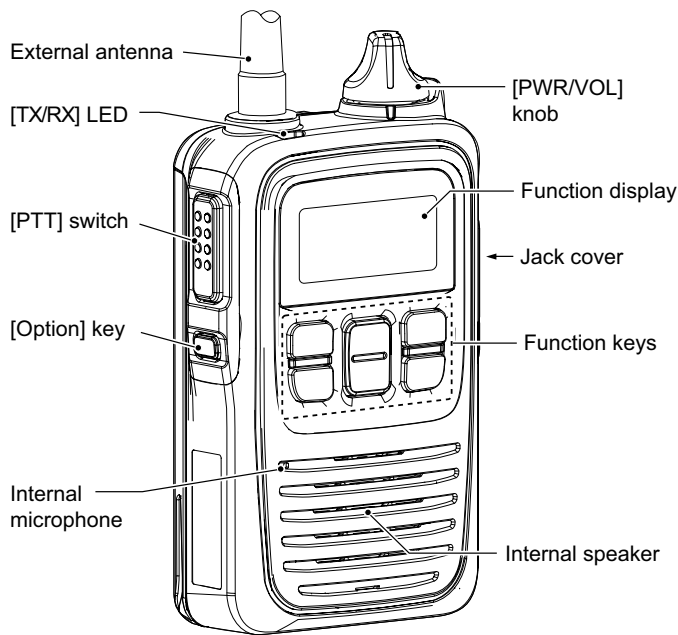

The indicators on the IP100H screen

• Standby screen

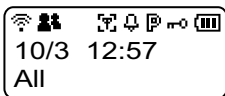

📶 Signal strength indicator

Displays the signal strength in three levels when your communication terminal is in a service area.

📶: Blinks when you are in out of the service area.

📶: Displayed when your communication terminal is not registered, or when not connected to a RoIP Gateway.

• When receiving a message

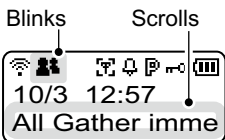

Standby screen

👤 Call mode icon

Displays the current call mode.

The icon blinks when a call or a message is received.

👤: All or Group call

👤: Individual call

👤: Talkgroup call

👤: Telephone call

• Talkgroup screen

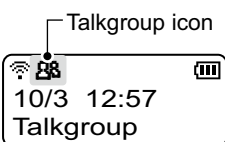

Talkgroup icon



Area call function icon



Pocket Beep function icon



P-Bell function icon



Key lock function icon



Battery indicator

Configuring the wireless LAN transceiver system

Transceiver Controller > Transceiver Settings > Transceiver Settings

The Transceiver Settings

Set up each registered transceiver.

① After completing the settings on this screen, restart the IP100H to apply them.

- 1 Open the Transceiver Settings screen.
(Transceiver Controller > Transceiver Settings > Transceiver Settings)
- 2 In [Transceiver Settings], select the Unit ID that you want to set up, and then enter the required settings.

Transceiver Settings

Unit ID : 0101 (Sales1) ① Select

Display Item : Date and Time Name

BackLight : Auto

Transmission Tx Inhibit : Disable Enable

PTT Lock : Disable Enable ② Enter

Destination ID PTT Call at Stand-by : Disable Enable * The last-used ID display is hidden, if disabled.

Use ID List : Disable Enable

Fix Call Destination : Disable

Key Assignment Option Key : No Function

Clear Down during Telephone Call : Disable Enable

To call to an IP telephone, enable "Clear Down during Telephone Call" or assign "Clear Down" to the "Option key."

Push [OPTION]

You can hang up the call by pushing [OPTION].
① Only for the individual call from an IP telephone or a call from the IP100H to an IP telephone.

- 3 Click <Apply>.

Read/Write Password : _____

Apply Reset Click

- 4 Confirm the setting in "Transceiver Setting List."

Transceiver Setting List

Transceiver Model	Name	Unit ID	Use ID List	Area Call	Message	Status	Option Key
IP100H	Sales1	0101	Enable	Enable	Enable	Enable	No Function
IP100H	Sales2	0102	Enable	Enable	Enable	Enable	No Function
IP100H	Sales3	0103	Enable	Enable	Enable	Enable	No Function

Confirm

Configuring the wireless LAN transceiver system

Destination Settings > Destination Settings

■ The Group Call

When registering IP100Hs or IP100FSs to a group, you can communicate in full-duplex, between three or more members in a conference call mode.

① You have to enter a Group and the Phonebook on the setting screen to make a Group Call.

① After completing the settings on this screen, restart the IP100H to apply them.

1 Open the Destination Settings screen.
(Destination Settings > Destination Settings)

2 In [Destination Settings], enter Name, Call Type, and Destination ID (4 digit), select the target wireless LAN transceivers to add to the Group, and then click <Apply>.

The screenshot shows the 'Destination Settings' screen. A box highlights the input fields for Name (Sales 01), Call Type (Group), Destination ID (0005), and Group Priority (Normal). A callout '① Enter' points to this box. Below, the 'Destination' section shows 'WLAN Transceivers' with a list of checked items: All, 0101(Sales1), 0102(Sales2), 0103(Sales3), and 0050(IP100FS). A callout '② Select' points to this list. At the bottom right, the 'Apply' button is highlighted with a callout '③ Click'.

3 Confirm the setting in the [List of Destination Setting Entries (Group Call)].

The screenshot shows the 'List of Destination Setting Entries (Group Call)' screen. A table lists the settings for the group. A callout 'Confirm' points to the table.

<input type="checkbox"/>	All	No.	Name	Destination ID	Group Priority	Number of WLAN Transceivers	Additional Controller	IP Transceiver Controller/Connection Port
<input type="checkbox"/>		5	Sales 01	0005	Normal	4	-	Not Set

Buttons: Edit, Delete, Delete Selected, Delete All

Configuring the wireless LAN transceiver system

Destination Settings > Destination Settings

■ The Talkgroup Call

You can join a Talkgroup by selecting it from the preset Talkgroups on your IP100H. You can make a call to the selected Talkgroup.

① You have to set about the Talkgroup Call and enter Talkgroup IDs to your phonebook.

① The Talkgroup function is assignable to the [FUNC] key or the [ID LIST] (ID LIST) key. (See the next page)

① After completing the setting on this screen, restart the IP100H to apply them.

1 Open the Destination Settings screen.
(Destination Settings > Destination Settings)

2 In [Destination Settings], enter Name, Call Type, and Talkgroup ID (4 digit), and then click <Apply>.

Destination Settings

No. : 11
 Name : TG1
 Call Type : Talkgroup
 Destination ID : 0091

Talkgroup Type : Normal Multiplex Talkgroup

Destination
 Communication Type : Simplex Full-Duplex
 Talkgroup Call for IP100FS : Disabled Enable
 Callee ID for IP100FS : All Appointment

Additional Controller : None

IP Transceiver Controller/Connection Port

All Digital Transceiver1 (D-TRX1) Digital Transceiver2 (D-TRX2) Digital Transceiver3 (D-TRX3)
 Digital Transceiver4 (D-TRX4)
 EXT I/O1 (EXT1) EXT I/O2 (EXT2) EXT Input3 (EXT3) EXT Output3 (EXT3)
 EXT Input4 (EXT4) EXT Output4 (EXT4)
 Emergency Notification
 Microphone (MIC)
 RoIP Gateway1 RoIP Gateway2 RoIP Gateway3 RoIP Gateway4 RoIP Gateway5
 RoIP Gateway6 RoIP Gateway7 RoIP Gateway8

Apply [Next] [Back]

3 Confirm the setting in the [List of Destination Setting Entries (Talkgroup Call)].

List of Destination Setting Entries (Talkgroup Call)

<input type="checkbox"/> All	No.	Name	Destination ID	Additional Controller	IP Transceiver Controller/Connection Port	
<input type="checkbox"/>	11	TG1	0091	-	Set	Edit Delete

Delete Selected Delete All

Configuring the wireless LAN transceiver system

■ The Talkgroup Call

Selecting the Talkgroup call using the IP100H

○ Using the [FUNC] key

Usable only when the Talkgroup Call function is assigned to the [FUNC] key.

1. Push [FUNC] several times to select a Talkgroup.
 - ① Push [FUNC] to select the assigned functions such as Message, Status, Area Call, and so on.
2. Push [▲] or [▼] to select the Talkgroup ID.
3. Push [CLR] to return to the standby screen.
 - ① You can talk with the IP100Hs or IP100FSs that are set to the same group number. (Example: 0091)
 - ① When you select Talkgroup Call, you are released from your previous selected group.
 - ① When "OFF" is selected in step 2, the Talkgroup is released.

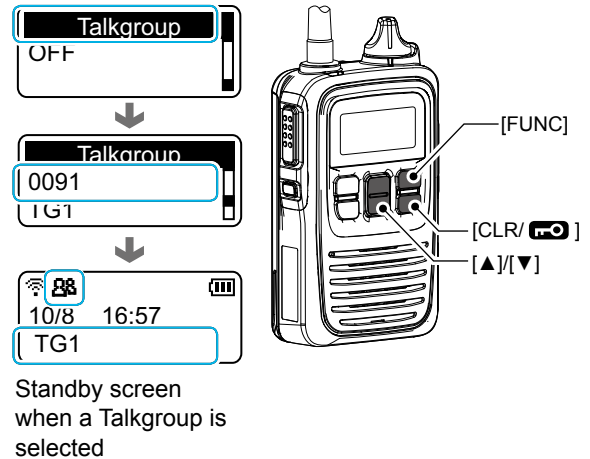

○ Using the [ID LIST] key

Usable only when the Talkgroup Call function is assigned to the [ID LIST] key.

1. Push [ID LIST] several times to select Group (or Talkgroup.)
 - ① Push [ID LIST] to select the assigned functions such as All, Individual, and so on.
2. Push [▲] or [▼] to select a Talkgroup number.
3. Push [CLR] to return to the standby screen.
 - ① You can talk with the IP100Hs or IP100FSs that are set to the same group number. (Example: 0091)
 - ① When you select Talkgroup Call, you are released from your previous selected group.
 - ① When "Group" is selected in step 2, the Talkgroup is released.

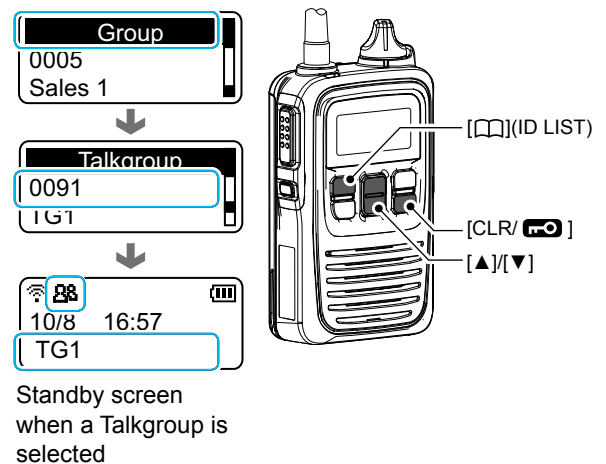

Configuring the wireless LAN transceiver system

Transceiver Controller > Common Settings > ID List

The ID List

Enter names, call types and so on into an ID list that the IP100H will use.

① Set "Use ID List" to "Enable" to use the ID list.

(Transceiver Controller > Transceiver Settings > Transceiver Settings > Transceiver Settings)

① After completing the settings on this screen, restart the IP100H to apply them.

1 Open the ID List screen.
(Transceiver Controller > Common Settings > ID List)

2 In [ID List Common Settings], select an ID list common setting number (Example: 1) that you want to register.

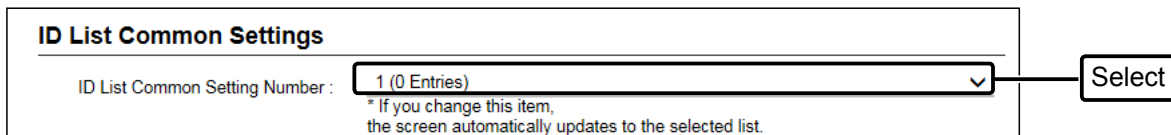

ID List Common Settings

ID List Common Setting Number : 1 (0 Entries) ▼ Select

* If you change this item, the screen automatically updates to the selected list.

① You can enter up to 50 ID List Common Setting groups.

3 In [ID List], click "Select From List," check the IDs that you want to add to the ID List, and then click <Apply>.

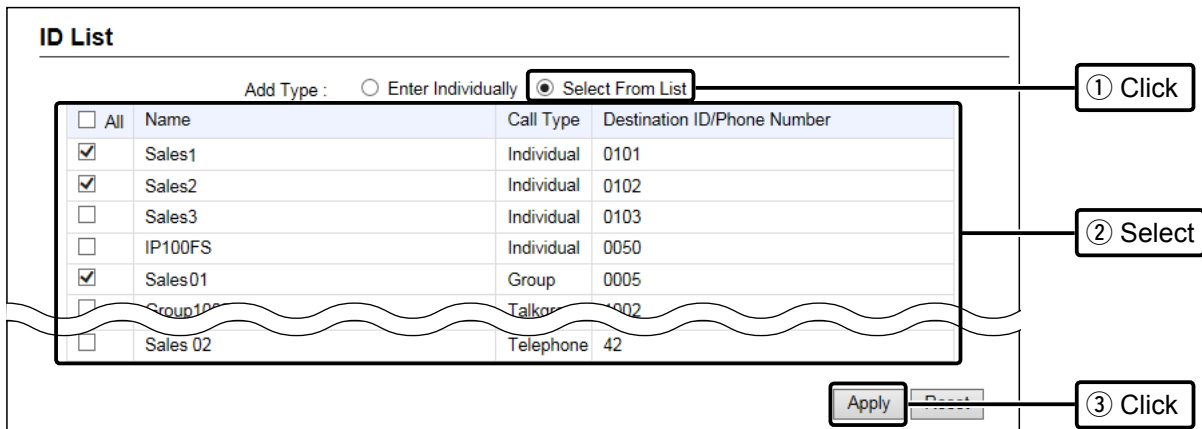

ID List

Add Type : Enter Individually Select From List

<input type="checkbox"/> All	Name	Call Type	Destination ID/Phone Number
<input checked="" type="checkbox"/>	Sales1	Individual	0101
<input checked="" type="checkbox"/>	Sales2	Individual	0102
<input type="checkbox"/>	Sales3	Individual	0103
<input type="checkbox"/>	IP100FS	Individual	0050
<input checked="" type="checkbox"/>	Sales01	Group	0005
<input type="checkbox"/>	Group100	Talko	0002
<input type="checkbox"/>	Sales 02	Telephone	42

Apply Reset

4 After registration is finished, confirm the registered contents in the [ID List Entries].

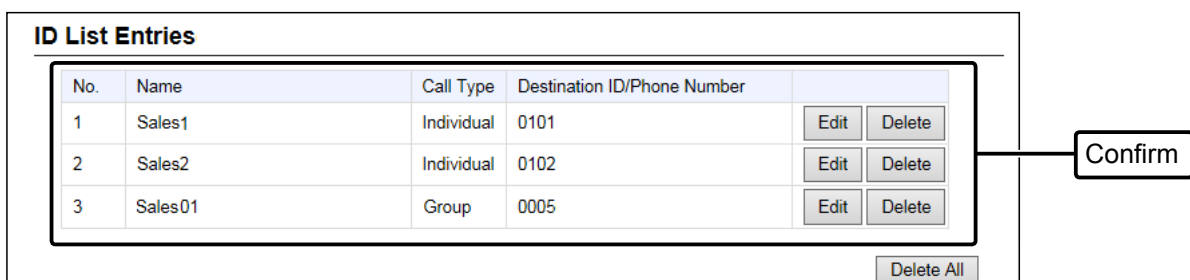

ID List Entries

No.	Name	Call Type	Destination ID/Phone Number	
1	Sales1	Individual	0101	Edit Delete
2	Sales2	Individual	0102	Edit Delete
3	Sales01	Group	0005	Edit Delete

Delete All

Configuring the wireless LAN transceiver system

Transceiver Controller > Common Settings > Messages

■ The Messages

Enter messages that the IP100H will transmit.

① Set "Message" to "Enable" to use the Message.

(Transceiver Controller > Transceiver Settings > Transceiver Settings > Transceiver Settings)

① After completing the settings on this screen, restart the IP100H to apply them.

1 Open the Messages screen.
(Transceiver Controller > Common Settings > Messages)

2 In [Message Group], select the Message Group number (Example: 1) that you want to enter messages into.

3 In [Message List], enter a message of up to 32 characters, and then click <Apply>.

① Up to 10 messages can be entered into each Message Group.

The screenshot shows the 'Messages' configuration screen. At the top, there is a 'Message Group' section with a dropdown menu set to '1 (0 Messages)'. Below this is a 'Message Group Detail' section. The main part of the screen is the 'Message List', which contains a table with 10 rows. The first row is highlighted, and a box is drawn around it. A line points from a '1 Enter' callout to the text input field of the first row. At the bottom right, there are 'Apply' and 'Reset' buttons, with a line pointing from a '2 Click' callout to the 'Apply' button.

No.	Fixed Message
1	Gather immediately.
2	A message was sent.
3	Check the message.
4	Is it no problem?
5	Give me a reply.
6	Give me a reply immediately.
7	Please disperse there.
8	Back to the office ASAP.
9	The parcel arrived.
10	The work finished.

Configuring the wireless LAN transceiver system

Transceiver Controller > Common Settings > Status

■ The Status

Enter a status that the IP100H will transmit.

① Set "Status" to "Enable" to use the status.

(Transceiver Controller > Transceiver Settings > Transceiver Settings > Transceiver Settings)

① After completing the settings on this screen, restart the IP100H to apply them.

1 Open the Status screen.
(Transceiver Controller > Common Settings > Status)

2 Enter status message of up to 32 characters, and then click <Apply>.

① Up to 10 status messages can be entered.

① Uncheck the box on the left of the status message, if you do not want to display it on the IP100H.

The screenshot shows the 'Status Settings' screen. It features a table with columns for 'All', 'Status No.', and 'Status Name'. The 'All' column contains checkboxes for each status. The 'Status Name' column contains text input fields for each status. A box highlights the 'Status Name' column, with an arrow pointing to a callout box labeled '① Enter'. At the bottom right, there are 'Apply' and 'Reset' buttons, with an arrow pointing to a callout box labeled '② Click'.

<input checked="" type="checkbox"/> All	Status No.	Status Name
<input checked="" type="checkbox"/>	1	Meeting
<input checked="" type="checkbox"/>	2	Away from the desk
<input checked="" type="checkbox"/>	3	At lunch
<input checked="" type="checkbox"/>	4	Under a round
<input checked="" type="checkbox"/>	5	At the desk
<input checked="" type="checkbox"/>	6	Working
<input checked="" type="checkbox"/>	7	Waiting
<input checked="" type="checkbox"/>	8	Under preparation
<input checked="" type="checkbox"/>	9	In progress
<input checked="" type="checkbox"/>	10	Under a break

① Enter

② Click

Configuring the wireless LAN transceiver system

Transceiver Controller > Common Settings > Profile

Setting the common ID List and Messages in the group

You can set the ID list and messages that are commonly used by the IP100Hs in a particular group.

① After completing the settings on this screen, restart the IP100H to apply them.

- 1 Open the Profile screen.
(Transceiver Controller > Common Settings > Profile)
- 2 In [No.], select a setting group number that you want to use.
① The group number is one that is entered on the Transceiver Registration screen.
- 3 Select ID List and Message List numbers that you want to use in the setting group.

Profile

No. : 1 (Sales group) ▼
* If you change this item, the screen automatically updates to the selected profile.

Name : Sales group

Wireless LAN
 Wireless LAN : Transceiver's Setting ▼

Common Settings
 ID List : 1 ▼
 Message List : 1 ▼

Registration
 Controller IP : _____
 Registration Retry Int. : _____ seconds
 Number of Registr. : _____
 Expire Time : 180 seconds

Select the specified ID list group on the "ID List" screen or message group on the "Messages" screen.

- 4 Click <Apply>.

TOT : Disable Enable

PBX Connection
 Use PBX Connection : None ▼

Apply Reset

- 5 Confirm the entry in [Profile List].

Profile List

No.	Name	Wireless LAN	ID List Number	Common Message Group
1	Sales group	Transceiver's Setting	1	1

2

Add Edit Delete

Delete All

Before using the PBX	4-2
■ Installation overview	4-2
Configuring the PBX system	4-3
■ Connecting to the SIP phones	4-3
■ Registering the SIP phones to the VE-PG4	4-4
■ Setting the Special Numbers.....	4-5
■ Setting for the SIP phones.....	4-6
Extension settings for the transceiver controller telephone connection	4-7
Destination Settings for the telephones	4-8
Destination settings for the transceivers	4-9
Setting up the KX series SIP phones	4-10
■ Setting up overview.....	4-10
■ Assigning a static IP address to the KX-UT series phones	4-11
■ Assigning a static IP address to the KX-HDV series phones	4-12
■ Using an external DHCP server (KX-UT series)	4-13
■ Using an external DHCP server (KX-HDV series).....	4-14
■ Setting the Provisioning on the Embedded Web screen	4-15
Using the KX series SIP phones	4-16
■ The Button functions of the SIP phone (KX-UT series)	4-16
■ Basic operation on the KX-UT series phones.....	4-18
■ The Button functions of the SIP phone (KX-HDV series).....	4-19
■ Basic operation on the KX-HDV series phones	4-21

Before using the PBX

■ Installation overview

The following shows a typical setting procedure for the PBX system in the VE-PG4 Setting screen.

1 Network settings

- **Network Settings > IP Address**

Enter the IP address according to your network environment. (Default: 192.168.0.1)

- **Network Settings > DHCP Server**

Enable or disable the built-in DHCP server function. (Default: Disable)

2 IP Line Settings

Set the connection to the upstream SIP server, or Peer to Peer SIP URI, according to your network environment. Refer to your upstream SIP server settings.

- **IP Line Settings > IP Line**

- **IP Line Settings > Peer to Peer**

3 PBX settings

- **PBX > Basic / Special Number**

Set the "Music on Hold" and special numbers.

(pp.4-4 ~ 4-6)

- **PBX > Extension / Extension Group / Inbound Call**

Register extension terminals (SIP phones), the preset external phone number, the model name of each extension telephone, ring tones for incoming internal and external calls, extension priority assignment for the inbound calls, and so on.

(p.4-7)

- **PBX Extension > Telephone / Phonebook** (for KX series telephones)

If desired, enter the SIP phone's key function assignments and phonebook.

4 Destination Settings for the telephones

Assign the extension numbers to the extension terminals registered in the step 3 above.

(p.4-8)

5 Destination settings for the transceivers

- **PBX Transceiver Call Settings > Callee ID to Phone Number**

Assign the extension number and call type to each destination transceiver.

(p.4-9)

6 Detailed settings for telephone - transceiver communications

- **PBX Extension > Transceiver Controller Telephone Connection**

If required, set the details for the transceiver controller telephone connection, such as notice tones, PTT control settings, and release timer.

(Operating guide)

7 Setting up the telephones

Connect the IP phones to the VE-PG4, and then do the initial settings on each IP phone to control them by the VE-PG4.

(pp.4-10 ~ 4-21)

① See also the manual supplied with the IP telephones.

Configuring the PBX system

■ Connecting to the SIP phones

You can connect up to 25 SIP phones to the VE-PG4.

① The KX series SIP phones (by Panasonic) are available. (As of May, 2019)

① Each SIP phone must be assigned a unique extension number.

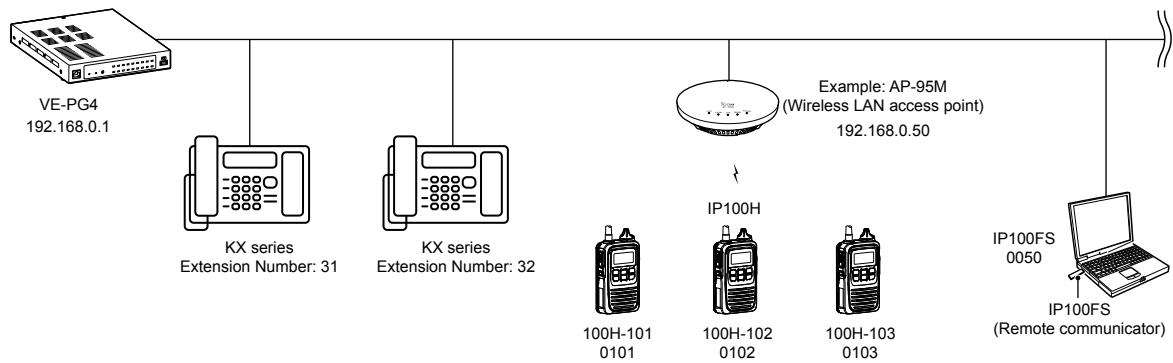

Configuring the PBX system

PBX > Extension

■ Registering the SIP phones to the VE-PG4

Enter an extension number for each SIP phones.

- 1 Open the Extension screen of the VE-PG4 setting screen.
(PBX > Extension)
- 2 In the [Extension], enter the following items, and then click <Apply>.

The screenshot shows the 'Extension' configuration screen. A box highlights the 'Port Type' dropdown (set to 'SIP Phone (Automatic Detection)'), 'Index' (1), 'Name' (Sales 01), 'Extension Number' (31), 'Password' (masked with dots), 'Extension Number Notification on Outbound Call' (Not Notify), 'IP Line' (No use), 'Peer to Peer' (No use), and 'Connection from WAN' (Deny). A callout '1 Enter' points to the 'Extension Number' field. Another callout '2 Click' points to the 'Apply' button. A third callout box says 'Check the MAC address of the SIP phone and enter it.' with a line pointing to the 'MAC Address' field.

- 3 Confirm the entered extensions in the [List of Extension Entries].

The screenshot shows the 'List of Extension Entries' screen. It contains a table with columns: All, Port Type, Index, Name, Extension Number, and Advanced Settings. The table lists four entries for SIP phones with indices 1 through 4. A callout box labeled 'Confirm' points to the 'Advanced Settings' column of the first entry.

<input type="checkbox"/> All	Port Type	Index	Name	Extension Number	Advanced Settings
<input type="checkbox"/>	SIP Phone (Automatic Detection)	1	Sales 01	31	Advanced Edit Delete
<input type="checkbox"/>	SIP Phone (Automatic Detection)	2	Sales 02	32	Advanced Edit Delete
<input type="checkbox"/>	SIP Phone (Automatic Detection)	3	Sales 03	33	Advanced Edit Delete
<input type="checkbox"/>	SIP Phone (Automatic Detection)	4	Sales 04	34	Advanced Edit Delete

The assignable numbers to the extensions

- Assign a 2 ~ 7 digit number.
 - Avoid the numbers for emergency calls in your local area.
 - Do not use "0" for the first digit.
- ① Set up both the VE-PG4 and the SIP phones to use the extensions.
① See also the manual of your SIP phones about their installation and its operation.

Extension Batch Setting

You can register 2 or more extensions with sequential numbering, or copy the setting contents to other extensions all at once.
(PBX > Extension > Extension Batch Setting)

Configuring the PBX system

PBX > Special Number

■ Setting the Special Numbers

Set the Special Numbers to operate with telephones that do not have flexible buttons.

- 1 Open the Special Number screen of the VE-PG4 setting screen.
(PBX > Special Number)
- 2 Enter the Special Numbers, and then click <Apply>.
 - Leave these settings as default, unless there is a particular reason not to.
 - Enter up to a 3 digit (0 ~ 9, #, *) number.
 - Avoid the numbers for emergency calls in your local area.
 - Do not use "0" for the first digit.
 - Do not duplicate the extension numbers or another Special Numbers.

Common Special Number	
Call Pickup :	*81
Group Pickup :	**
Direct Pickup :	*80
System Special Number :	*82 *93 *85 *88 *89 *99 *84 *86 *76 *97 *98 *77 *87
Telephone Special Number	
Call Park :	*90
Unpark Call :	*91
Inbound Call Pickup :	*92
Speaker Call :	*83
Call Forward Always :	*94
Call Forward No Answer :	*95
Call Forward Busy :	*96
Transceiver Special Number	
OFF-hook for Dialing :	
OFF-hook for Answering :	#
ON-hook :	#
Immediate Calling :	None <input type="checkbox"/>
Transceiver Call Prefix	
Individual Call :	*
Group Call :	#
All Call :	**

① Enter
② Click

Configuring the PBX system

PBX Extension > Telephone (KX-UT Series)

PBX Extension > Telephone (KX-HDV Series)

■ Setting for the SIP phones

Set up your KX-UT or KX-HDV series SIP phones and assign the key functions to the flexible buttons. (Example: KX-UT series)

1 Open the Telephone (KX-UT Series) screen. (PBX Extension > Telephone (KX-UT Series))

2 In the [Select Group Setting], select a group that you want to edit, and then click <Edit>.

Telephone Group

Select Group Setting : Group 1

Edit

① Select

② Click

3 Assign the functions to each flexible buttons, and then click <Apply>.

Telephone Common Settings

Pickup Group Number : 01

Call Pickup Target : Extension Only

Group Pickup Target : External Call/Extension

Button 2	Button 14
DN Key	DN Key
Button 1	Button 13
DN Key	DN Key

Apply

① Enter

② Click

Extension settings for the transceiver controller telephone connection

PBX > Extension

Assign the extension number for communicating between the telephone and a transceiver that is linked to the VE-PG4.

- 1 Open the Extension screen.
(PBX > Extension)
- 2 In [Extension], set Port Type to “Transceiver Controller Telephone Connection,” enter Name and Extension Number (2 ~ 7 digit,) and then click <Apply>.

Extension

Port Type : Transceiver Controller Telephone Connection ▼

Name : _____

Extension Number : 3000 ① Enter

Extension Number Notification on Outbound Call : Not Notify ▼

IP Line : No use ▼

Peer to Peer : No use ▼

Apply
Reset
② Click

- 3 Confirm the entry in [List of Extension Entries].

List of Extension Entries

<input type="checkbox"/>	Port Type	Index	Name	Extension Number	Advanced Settings		
<input type="checkbox"/>	SIP Phone (Automatic Detection)	1	Sales 01	31	Advanced	Edit	Delete
<input type="checkbox"/>	SIP Phone (Automatic Detection)	2	Sales 02	32	Advanced	Edit	Delete
<input type="checkbox"/>	SIP Phone (Automatic Detection)	3	Sales 03	33	Advanced	Edit	Delete
<input type="checkbox"/>	SIP Phone (Automatic Detection)	4	Sales 04	34	Advanced	Edit	Delete
<input type="checkbox"/>	Transceiver Controller Telephone Connection	-		3000		Edit	Delete

Delete Selected Items
Delete All
Confirm

Example: Calling the wireless LAN transceiver (0101) from the SIP phone (extension 31)

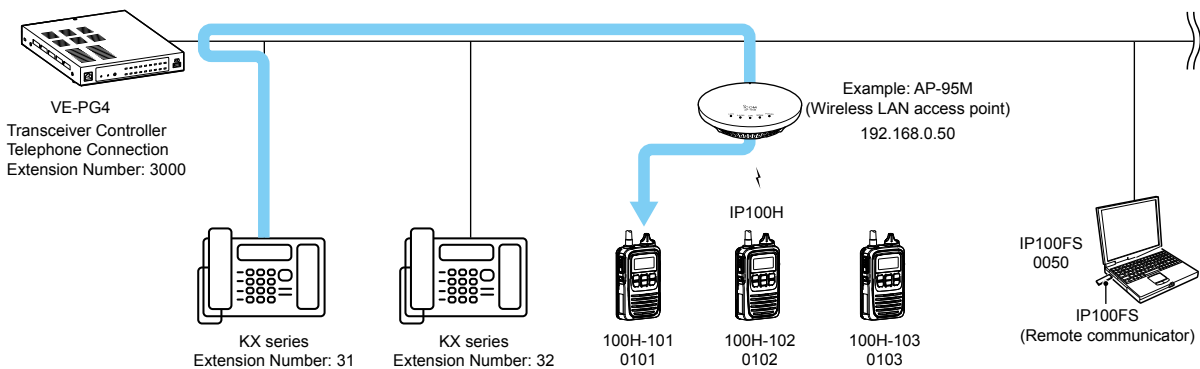

Pick up the SIP phone handset, and then dial [the extension number of the transceiver controller telephone connection], [Transceiver Call Prefix], and [Unit ID]. (Example: 3000*101)

Destination Settings for the telephones

Destination Settings > Destination Settings

Enter the extension numbers to the registered telephones.
To call a SIP phone from a wireless LAN transceiver, you have to add the SIP phone to the Destination Settings.

- 1 Open the Destination Settings screen.
(Destination Settings > Destination Settings)
- 2 In the [Destination Settings], Set Call Type to “Telephone,” enter Name, and enter the SIP phone’s Extension Number in Destination ID (example: 31,) and then click <Apply>.

Destination Settings

No. : 1

Name : Sales 01

Call Type : Telephone

Destination Phone Number : 31

Apply Reset

① Enter

② Click

- 3 Confirm the entry in [List of Destination Setting Entries (Telephone)].

List of Destination Setting Entries (Telephone)

<input type="checkbox"/> All	No.	Name	Destination Phone Number	Edit	Delete
<input type="checkbox"/>	1	Sales 01	31	Edit	Delete
<input type="checkbox"/>	2	Sales 02	32	Edit	Delete

Delete Selected Delete All

Confirm

Destination settings for the transceivers

PBX Transceiver Call Settings > Callee ID to Phone Number

Set a converted phone number for each SIP phone.

The converted destination is used to call a SIP phone from a digital transceivers or the transceivers that are linked to the VE-PG4 through the [EXT] port.

- 1 Open the Callee ID to Phone Number screen.
(PBX Transceiver Call Settings > Callee ID to Phone Number)

- 2 In [Callee ID to Phone Number], enter the following items, and then click <Add>.
 - Destination ID: The number that the caller transceiver uses to call a SIP phone
 - Phone Number: The extension number of the SIP phone (2 ~ 7 digit)

Callee ID to Phone Number

Index	Name	Callee ID			Phone Number
		Call Type	Prefix ID	Destination ID	
1	Sales 01	Individual	1	31	31

① Enter (points to the Destination ID field)

② Click (points to the Add button)

- 3 Confirm the entry in [List of Callee ID to Phone Number Entries].

List of Callee ID to Phone Number Entries

Index	Name	Callee ID			Phone Number	
		Call Type	Prefix ID	Destination ID		
1	Sales 01	Individual	1	31	31	Edit Delete
2	Sales 02	Individual	1	32	32	Edit Delete

Confirm (points to the table)

Setting up the KX series SIP phones

■ Setting up overview

When connecting the KX series SIP phones to the VE-PG4, you may be required to do “Pre-provisioning,” on the SIP phone web setting screen, in the initial setup procedure, depending on your network environment.

Complete the initial settings described above in this section before doing the SIP phone settings described hereafter.

① Also, see the manual supplied with your SIP phone or other devices.

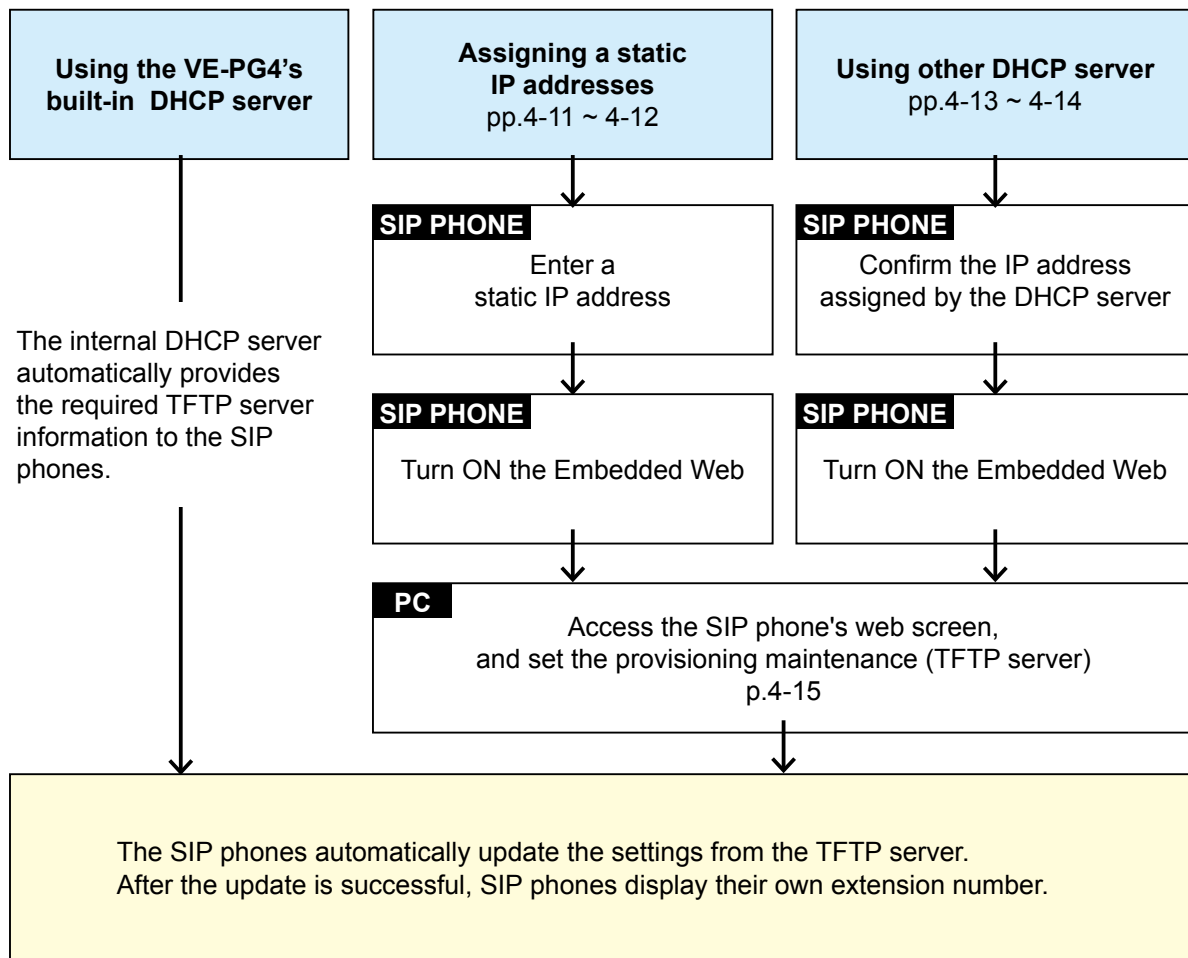

NOTE:

- Do not access the SIP phone’s Embedded Web except during the initial setting. Otherwise the VE-PG4 will not be able to control the SIP phone.
- Reboot the SIP phone after you have accessed the SIP phone’s web screen, to enable control of the SIP phone from the VE-PG4.
- If the “403 Forbidden error” message is displayed while accessing the SIP phone’s Embedded Web, turn OFF the Embedded Web of the SIP phone, and then turn it ON again.

When you cannot receive the setting data from the TFTP server during the initial setting:

- Confirm the MAC address of the SIP phone is correctly entered to the VE-PG4.
- When using the SIP phones with a static IP address, or when using another DHCP server than the VE-PG4, the setting data may not be correctly received.
Disconnect any other DHCP servers in the same network, or initialize the SIP phone and set it up again.

Setting up the KX series SIP phones

■ Assigning a static IP address to the KX-UT series phones

Assign a static IP address, and do the Pre-provisioning procedure for the SIP phone. Refer to the manual provided with the SIP phone for details.

1 Without connecting to the DHCP server or to the currently working network, turn ON the SIP phone.

2 Enter the static IP address of the SIP phone.

① Use the software keys below the display and cursor to move in the menu, and push <OK> or <Enter> to apply.

① Turn ON the SIP phone, and then push <Setting> or <Setup>.

② Open the static IP Address setting screen.

(<Setup> > Network Settings > Network > Static)

③ Enter the IP Address of the SIP phone, and push <Enter>.

④ Enter the Subnet Mask, and then push <Enter>.

⑤ Push <CANCEL>.

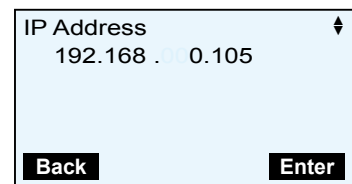

3 Turn ON the Embedded Web port.

① Open the Embedded Web screen.

(<Setup> > Network Settings > Embedded web)

② Select "On," and then press <Enter>.

③ Press <CANCEL>.

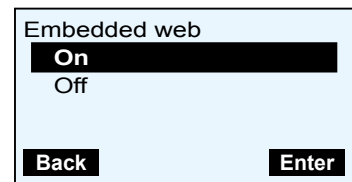

4 Push <CANCEL>.

5 Connect the SIP phone to the network.

6 Continue to do the Pre-provisioning described on page 4-15.

Setting up the KX series SIP phones

■ Assigning a static IP address to the KX-HDV series phones

Assign a static IP address, and do the Pre-provisioning procedure for the SIP phone. Refer to the manual provided with the SIP phone for details.

1 Without connecting to the DHCP server or to the currently working network, turn ON the SIP phone.

2 Enter the static IP address of the SIP phone.

① Use the software keys below the display and cursor to move in the menu, and push <OK> or <Enter> to apply.

① Turn ON the SIP phone, and then push <Menu>.

② Open the static IP Address setting screen.

(<Menu> > System Settings > Network Settings > IPv4 Settings > Static)

③ Enter the IP Address of the SIP phone, and push <Next>.

④ Enter the Subnet Mask, and then push <OK>.



3 Turn ON the Embedded Web port.

① Open the Embedded Web screen.

(<Menu> > Basic Settings > Other Option > Embedded Web)

② Select "On," and then press <OK>.

③ Press <CANCEL>.

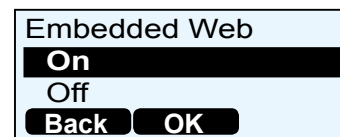

4 Connect the SIP phone to the network.

5 Continue to do the Pre-provisioning described on page 4-15.

Setting up the KX series SIP phones

■ Using an external DHCP server (KX-UT series)

When using a DHCP server other than the VE-PG4's built-in DHCP server, do the Pre-provisioning procedure for the SIP phone.

Refer to the manual provided with the SIP phone for details.

- 1 Connect to the DHCP server, and then turn ON the SIP phone.
 - The network settings will be automatically set.
- 2 Confirm the assigned IP address of the SIP phone.
 - ① Use the software keys below the display and cursor to move in the menu, and push <OK> or <Enter> to apply.
 - ② Push <Setting> or <Setup>.
 - ③ Open the IP Address status screen.
(<Setup> > Information Display > IP Address)
 - ④ Check the IP address, and then press <Back>.
 - ⑤ Press <CANCEL>.
- 3 Turn ON the Embedded Web port.
 - ① Open the Embedded Web screen.
(<Setup> > Network Settings > Embedded web)
 - ② Select "On," and then press <Enter>.
 - ③ Press <CANCEL>.
- 4 Continue to do the Pre-provisioning described on page 4-15.

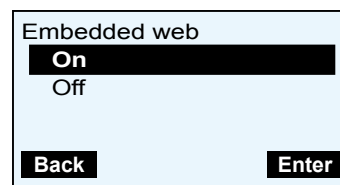
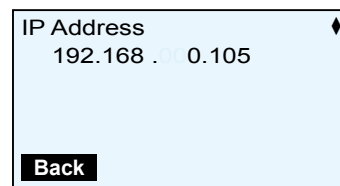

Setting up the KX series SIP phones

■ Using an external DHCP server (KX-HDV series)

When using a DHCP server other than the VE-PG4's built-in DHCP server, do the Pre-provisioning procedure to the SIP phone.

Refer to the manual provided with the SIP phone for details.

- 1 Connect to the DHCP server, and then turn ON the SIP phone.
 - The network settings will be automatically set.
- 2 Confirm the assigned IP address of the SIP phone.
 - ① Use the software keys below the display and cursor to move in the menu, and push <OK> or <Enter> to apply.
 - ① Push <Setting> or <Setup>.
 - ② Open the IP Address status screen.
(<Menu> > System Settings > Status > IPv4 Settings > IP Address)
 - ③ Check the IP address, and then press <Back>.
 - ④ Press <CANCEL>.
- 3 Turn ON the Embedded Web port.
 - ① Open the Embedded Web screen.
(<Menu> > Basic Settings > Other Option > Embedded Web)
 - ② Select "On," and then press <OK>.
 - ③ Press <CANCEL>.
- 4 Continue to do the Pre-provisioning described on page 4-15.

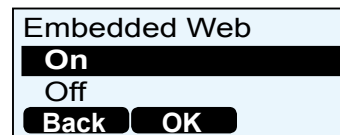

Setting up the KX series SIP phones

■ Setting the Provisioning on the Embedded Web screen

Enter the pre-provisioning (TFTP server) to the SIP phone, on its Embedded Web screen. The IP address of the SIP phone is required to access the Embedded Web screen.

- 1 Open the web browser of the PC that is connected to the same network as the SIP phone.
- 2 Enter the SIP phone's IP address, and then press the <Enter> key.
 - The login dialog is displayed.
- 3 Enter "admin" in the User name and "adminpass" in Password, and then click <OK>.
 - The Embedded Web screen is displayed.
- 4 Click "Maintenance" in the upper right of the screen.
- 5 Click "Provisioning Maintenance" on the left side of the screen.
- 6 In "Standard File URL", enter "tftp://(your VE-PG4's IP address)/{MODEL}_{MAC}.cfg", and then click <Save>.

(Example: when the IP address is 192.168.0.1)

tftp://192.168.0.1/[MODEL]_{MAC}.cfg

↓
Your VE-PG4's IP address

① For the KX-UT Series, restart the SIP phone to load the settings from the VE-PG4.

Resetting a SIP phone to the factory default

If you need to reset your SIP phone to the factory default for any troubleshooting, operate the SIP phone as follows:

KX-UT Series

1. Push <Setting> or <Setup>.
2. Dial "#136".
3. Select "Factory Setting," and then push <ENTER>.
4. Select "Yes," and then push <ENTER>.
5. Select "Yes," and then push <ENTER>.
 - The SIP phone loads the factory default and restarts.

KX-HDV Series

1. Push <MENU>.
2. Select "System Setting," and then push <ENTER>.
3. Dial "#136".
4. Select "Yes," and then push <ENTER>.
 - The SIP phone loads the factory defaults and then restarts.

Using the KX series SIP phones

■ The Button functions of the SIP phone (KX-UT series)

① See also the manual supplied with your SIP phone for details on the telephone operation.

① This manual description is based on the KX-UT136. The name or icon of the buttons may differ, depending on the telephones.

DO NOT DISTURB (.|).....

(Needed to be set in advance)
 You can set “Do Not Disturb” when you are busy and cannot answer calls.
 ① “Fwd All,” “Fwd Busy,” and “Fwd No Ans” are not usable.
 Assign the Flexible keys or Dial the special numbers to use these functions.

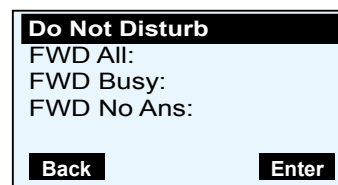

CONFERENCE (Δ)

Establishes a local three-way conference call.
 Push [CONFERENCE] or [HOLD] during the conversation, dial the number that you want to join the conference call, and then push [CONFERENCE] after the invited extension has answered.

FLASH/RECALL (R).....

Disconnects the current call and makes another call without hanging up. While transferring a call, push this key and then [TRANSFER] to cancel the transferring and return to the original call.

REDIAL (●)

Redials the last dialed number.

MESSAGE (✉)

Accesses the voice message server to check for received voice messages.
 Pushing while in the Standby screen enters the answering operation.

TRANSFER (↻).....

Transfers a call to another extension.
 While transferring a call, push [FLASH] and then this key to cancel the transfer and return to the call.

CANCEL

Cancels the call, or the setting operation.

HOLD (↵)

Puts a call on hold.

MUTE (Ⓜ)/AUTO ANSWER (Ⓜ)

MUTE: Mutes or unmutes during the call.
 The [SP-PHONE (📞)/HEADSET (🎧)] button blinks red while in the muted mode.
AUTO ANSWER: (Needs to be set in advance)
 Automatically answers an incoming call after ringing several times.

**SP-PHONE (📞)/
 HEADSET (🎧)**

You can talk hands-free, or with a headset if connected.

Using the KX series SIP phones

■ The Button functions of the SIP phone (KX-UT series)

Flexible button 1 ~ 24 Functions are assigned on the VE-PG4's setting screen.
 (PBX Extension > Telephone (KX-UT Series))
 ⓘ The assignable functions for the KX-UT136 are usable with other telephones
 (Example: KX-UT123) by dialing the special number for the function.

Button Type	Other telephones	Description
One Touch	–	(Dial the preset number to the One Touch button)
DN Key	–	KX-UT123N has 2 internal fixed DN keys
External Call Status	–	
Call Fwd Always	✓	Dial the Special Number for Call Forward Always
Call Fwd No Answer	✓	Dial the Special Number for Call Forward No Answer
Call Fwd Busy	✓	Dial the Special Number for Call Forward Busy
Headset	–	Valid on the KX-UT123N when a headset is connected

Refer to the Operating guide for details on the flexible button functions.

DN Keys

- You need at least 2 DN Keys, one for an incoming/outgoing call, and one to hold or transfer the call.
- If the number of DN keys is insufficient, you cannot hold a call or receive a new incoming call.
- On the KX-UT123 that does not have a flexible button, 2 fixed DN keys are internally assigned. When a new call is incoming while you are talking on the KX-UT123, you cannot answer a new call or hold the current call because of the DN key insufficiency. Hang up the current call to answer the new call.

Using the KX series SIP phones

■ Basic operation on the KX-UT series phones

Making a call

Dialing a number

You can pick up the handset before or after dialing.

Pushing a One Touch key

① To be assigned to a Flexible button.

Using a phonebook

1. Push **Phonebook**, and then **Search**.
2. Select an address, and then pick up the handset.

Using the call log

1. Push **Call Log**.
2. Select an address, and then pick up the handset.

Answering a call

On hook

(When answering the displayed caller)

Using a DN key

- Push the DN Key that is blinking fast in blue.

Rejecting a call

- Push **Reject**.
 - ① Except when the other extensions are ringing, the busy tone is returned to the caller.
 - ① The calling tone is returned to the caller who uses an analog telephone.

Picking up a call

- Dial the special number for picking up, and then pick up the handset.
 - ① You can push the One Touch button, if the special number for Call Pickup is assigned.

Holding or transferring a call

Holding a call

1. Push [HOLD] to hold the call.
2. Push the DN key that is slowly blinking in green to retrieve the held call.

Transferring to an extension

1. Push [Transfer] during the conversation.
2. Dial the extension you want to transfer the call to.
3. After the target is answered, push [Enter] or hang up.
 - ① You can cancel transferring by pushing [FLASH], and then push [TRANSFER].

Parking a call

1. Push [TRANSFER] during a conversation.
2. Dial the special number for parking (default: *90) and then the park number (01 ~ 24) during a conversation.

(For example, to park a call to park number 01: dial *9001)

 - The hold tone rings when the call is successfully parked. Hang up the handset.
 - ① Returns to the original call if you failed parking the call. Retry parking to another park number.

Unparking a call

- On the phone that you want to unpark the call, dial the special number for unparking (default: *91), and then the parked number (01 ~ 24.)

(For example, to unpark a call on park number 01: dial *9101)

Using the KX series SIP phones

■ The Button functions of the SIP phone (KX-HDV series)

① See also the manual supplied with your SIP phone for details on the telephone operation.

① This manual describes based on the KX-HDV230. The name or icon of the buttons may differ, depending on the telephones.

CANCEL	Cancels the call, or the setting operation.
CONFERENCE (Δ)	Establishes a local three-way conference call. Push [CONFERENCE] or [HOLD] during the conversation, dial the number that you want to join the conference call, and then push [CONFERENCE] after the invited extension has answered.
REDIAL (●)	Redials the last dialed number.
MUTE/AUTO ANS (③/📞)	MUTE: Mutes or unmutes during a conversation. The mute icon blinks on the screen while in the muted mode. AUTO ANS: (Needs to be set in advance) Automatically answers an incoming call after ringing several times.
HEADSET (🎧)	Makes on hook or off hook on the headset if connected.
MESSAGE (✉)	Accesses the voice message server to check for received voice messages. Pushing in standby screen enters the answering operation.
TRANSFER (↻)	Transfers a call to another extension. While transferring a call, push [Flash] and then this key to cancel the transfer and return to the original call.
HOLD (↵)	Puts a call on hold.
SP-PHONE (📞)	You can talk hands-free.
LINE1/P1	(Only for the KX-HDV130) Functions as Flexible button 1.
LINE2/P2	(Only for the KX-HDV130) Functions as Flexible button 2.

Using the KX series SIP phones

■ The Button functions of the SIP phone (KX-HDV series)

Flexible button 1 ~ 24 Functions are assigned on the VE-PG4's setting screen. (PBX Extension > Telephone (KX-HDV Series))
 ⓘ The assignable functions for the KX-HDV230 are usable with other telephones (Example: KX-HDV130) by dialing the special number for the function.

Button Type	Other telephones	Description
One Touch	–	Dial the preset number to the One Touch button
DN Key	–	For the KX-HDV130N: Available only when “DN key” or “Transfer” is assigned to <Line1/P1> or <Line2/P2>.
External Call Status	–	
Call Fwd Always	✓	Push the Special Number for Call Forward Always
Call Fwd No Answer	✓	Push the Special Number for Call Forward No Answer
Call Fwd Busy	✓	Push the Special Number for Call Forward Busy
Transfer	–	
Blind Transfer	–	
Conference	–	

Refer to the Operating guide for details on the flexible button functions.

DN Keys

- You need at least 2 DN Keys, one for an incoming/outgoing call, and one to hold or transfer the call.
- If the number of DN keys is insufficient, you cannot hold a call or receive a new incoming call.
- On the KX-HDV130, up to 2 DN keys can be assigned to [Line1/P1] and [Line2/P2], and the other DN key is internally used to hold or transfer a call.

Expand unit

- You can install up to 5 expand units. Refer to the Operating guide for details on the assignable functions.

Using the KX series SIP phones

■ Basic operation on the KX-HDV series phones

Making a call

Dialing a number

You can pick up the handset before or after dialing.

Pushing a One Touch key

① To be assigned to a Flexible button.

Using a phonebook

1. Push **Phonebook**, and then **OK**.
2. Select an address, and then pick up the handset.

Using the call log

1. Push **Call Log**.
2. Select an address, and then pick up the handset.

Answering a call

On hook

(When answering the displayed caller)

Using a DN key

- Push the DN Key that is blinking fast in blue.

Rejecting a call

- Push **Reject**.
 - ① Except when the other extensions are ringing, the busy tone is returned to the caller.
 - ① The calling tone is returned to the caller who uses an analog telephone.

Picking up a call

- Dial the special number for picking up, and then pick up the handset.
 - ① You can push the One Touch button, if the special number for Call Pickup is assigned.

Holding or transferring a call

Holding a call

1. Push [HOLD] to hold the call.
2. Push the DN key that is slowly blinking in green to retrieve the held call.

Transferring to an extension

1. Push [TRANSFER] during a conversation.
2. Dial the extension you want to transfer the call to.
3. After the target is answered, push [ENTER] or hang up.
 - ① You can cancel transferring by pushing [CANCEL] twice.

Parking a call

1. Push [TRANSFER] during a conversation.
2. Dial the special number for parking (default: *90) and then the park number (01 ~ 24) during a conversation.

(For example, to park a call to park number 01: dial *9001)

 - The hold tone rings when the call is successfully parked. Hang up the handset.
 - ① Returns to the original call if you failed parking the call. Retry parking to another park number.

Unparking a call

- On the phone that you want to unpark the call, dial the special number for unparking (default: *91), and then the parked number (01 ~ 24.)

(For example, to unpark a call on park number 01: dial *9101)

Checking and saving the settings	5-2
Restoring the saved settings	5-3
Resetting to the factory defaults	5-4
■ Pushing the <MODE> button	5-4
■ Resetting on the setting screen	5-5
Updating the firmware	5-6
■ About the firmware	5-6
■ Manual update	5-7
■ Online update	5-8
■ Online update with the <UPDATE> button	5-9
Automatic Restoring from a USB flash drive	5-10
■ Using a USB flash drive	5-10
■ Usable USB flash drive specifications	5-10
■ About the file names	5-11
■ The settings backup files	5-11
■ Managing 2 or more VE-PG4s with a USB flash drive	5-12
Restoring the settings from the USB flash drive	5-13
Updating the firmware from a USB flash drive	5-15
Issuing a USB authentication key	5-16

Checking and saving the settings

Management > Settings Backup/Restore

You can check the settings changed on the setting screen, and then save them as a setting file (format: .sav) on your PC.

- ① The saved file (.sav) is not usable on devices other than the VE-PG4.
- ① You can use the saved file as a backup if the settings are lost or damaged.

1 Open the Settings Backup/Restore screen.
(Management > Settings Backup/Restore)

2 In [Settings Backup], click <Backup>.
• The file confirmation screen is displayed.

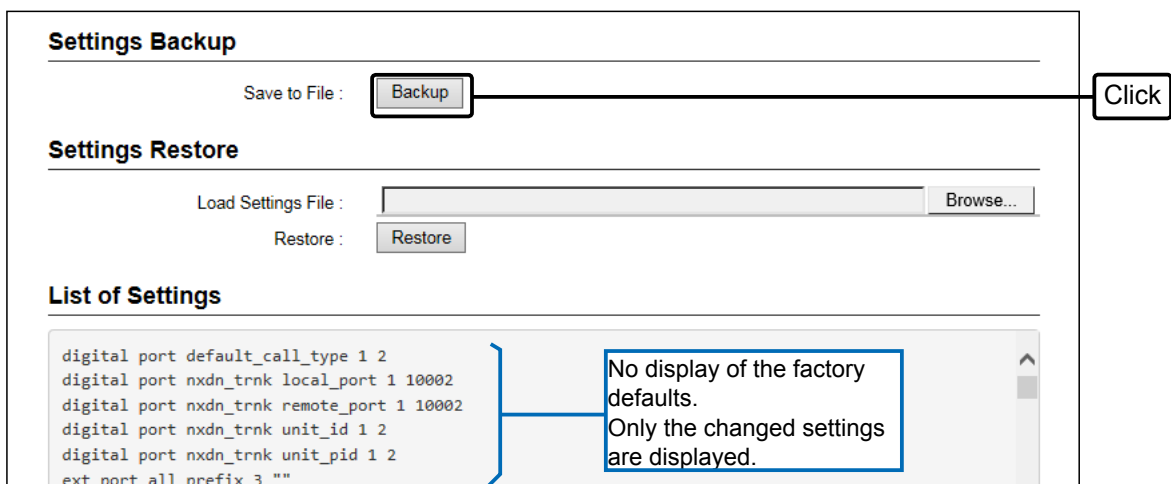

3 Click [▼] by the [Save] button, and then select "Save as."
• The "Save as" window is displayed.

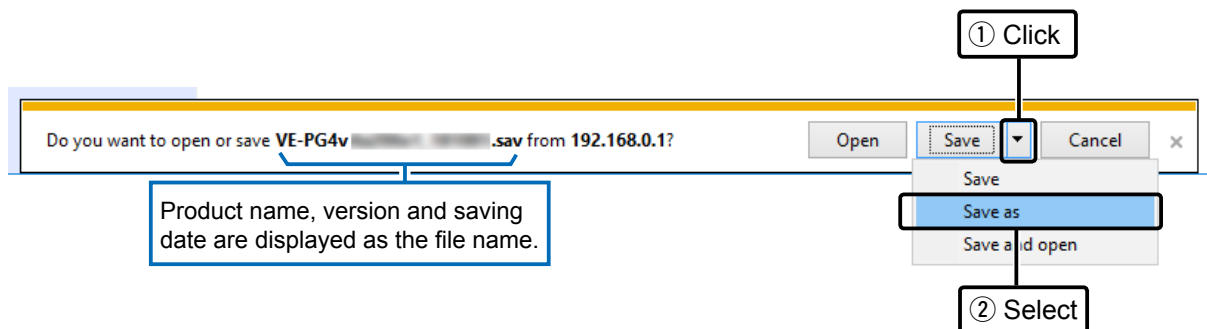

4 Select the location to save and click <Save>.
• The setting file is saved in the selected location.

Restoring the saved settings

Management > Settings Backup/Restore

You can restore a previously saved setting file in the previous page to the VE-PG4.

NOTE: DO NOT write the saved file to any other devices.

1 Open the Settings Backup/Restore screen.
(Management > Settings Backup/Restore)

2 In [Settings Restore], click <Browse>.
• The file selection screen is displayed.

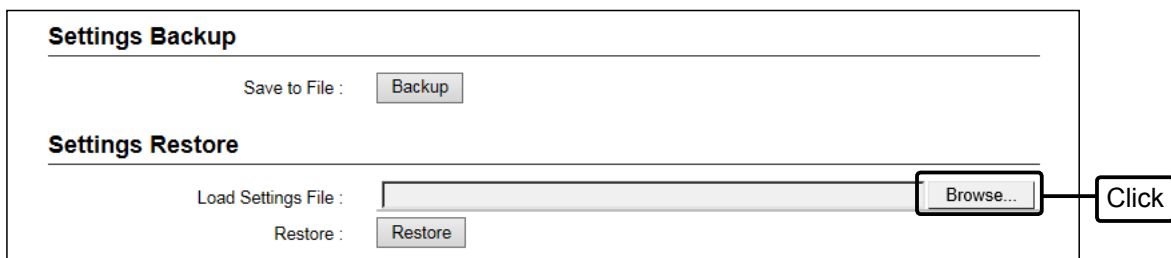

3 Select the setting file (format: .sav), and then click <Open>.
• The location of the setting file will be entered into the “Load Settings File.”

4 Click <Restore>, and then click <OK> on the confirmation dialog.
• The VE-PG4 restarts to restore the settings. It may take several minutes until it completely reboots.

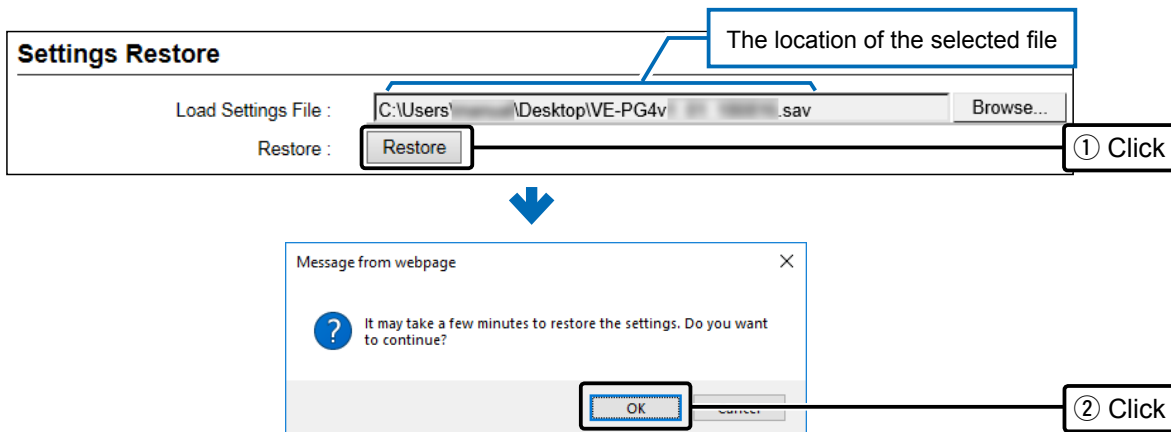

CAUTION: DO NOT turn OFF both the VE-PG4 and the PC while the VE-PG4 is restoring or rebooting.

5 After the VE-PG4 has completely rebooted, click “[Back]” (the red text on the screen) to return to the setting screen.

Resetting to the factory defaults

When you reconfigure your network, and so on, you can reset the VE-PG4 to the factory defaults. There are two ways to reset to the factory defaults. Choose an appropriate way, according to your situation.

- Pushing the <MODE> button: When the settings screen cannot be accessed because the IP address or password for the VE-PG4 is unknown.
- Using the setting screen: When you can successfully access the setting screen.

■ Pushing the <MODE> button

- 1 Disconnect all cables from the VE-PG4, and then connect the power adapter. Confirm that the [PWR] indicator lights in green.
 - ① The other indicators status may differ, depending on the operation status.

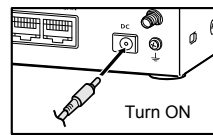

Indicators on the front panel

[PWR] lights green

[PWR]	4G/3G	PPP	RoIP	VoIP	D-TRX1	D-TRX2	D-TRX3	D-TRX4
MSG	WAN	VPN	USB1	MIC	EXT1	EXT2	EXT3	EXT4

- 2 Hold down the <MODE> button on the on panel with a pin, until all the indicators light orange.
 - The [MSG] indicator blinks green when the <MODE> button is held. Keep holding down it until all the indicators light orange.

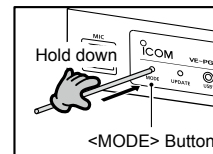

[PWR] lights green

[PWR]	4G/3G	PPP	RoIP	VoIP	D-TRX1	D-TRX2	D-TRX3	D-TRX4
MSG	WAN	VPN	USB1	MIC	EXT1	EXT2	EXT3	EXT4

[MSG] blinks green

[PWR]	4G/3G	PPP	RoIP	VoIP	D-TRX1	D-TRX2	D-TRX3	D-TRX4
MSG	WAN	VPN	USB1	MIC	EXT1	EXT2	EXT3	EXT4

All lights orange

- 3 Release the <MODE> button.
 - The [PWR] indicator lights green when the RoIP Gateway has completed resetting.

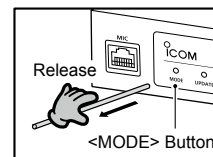

All blinks red → green

[PWR] Lights green

[PWR]	4G/3G	PPP	RoIP	VoIP	D-TRX1	D-TRX2	D-TRX3	D-TRX4
MSG	WAN	VPN	USB1	MIC	EXT1	EXT2	EXT3	EXT4

[PWR] Blinks green

[PWR]	4G/3G	PPP	RoIP	VoIP	D-TRX1	D-TRX2	D-TRX3	D-TRX4
MSG	WAN	VPN	USB1	MIC	EXT1	EXT2	EXT3	EXT4

[PWR] Lights green

[PWR]	4G/3G	PPP	RoIP	VoIP	D-TRX1	D-TRX2	D-TRX3	D-TRX4
MSG	WAN	VPN	USB1	MIC	EXT1	EXT2	EXT3	EXT4

NOTE: After resetting the VE-PG4 to the factory defaults, the IP address is set to “192.168.0.1.” If you cannot access the VE-PG4 setting screen, change your PC’s IP address.

Resetting to the factory defaults

Management > Factory Defaults

When you can access the setting screen with the IP address and the administrator’s password, you can restore all the default settings from the setting screen. If the IP address and the password are unknown, see the previous page.

■ Resetting on the setting screen

- 1 Open the Settings Factory Defaults screen. (Management > Factory Defaults)
- 2 Select “Restore all settings to factory defaults,” and then click <Restore>.

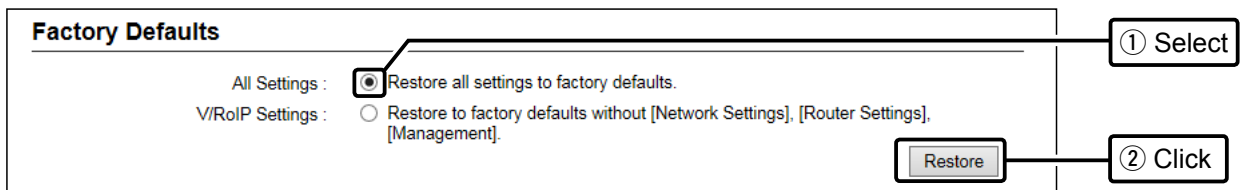

- The confirmation dialog is displayed.

- 3 Click <OK> on the confirmation dialog.

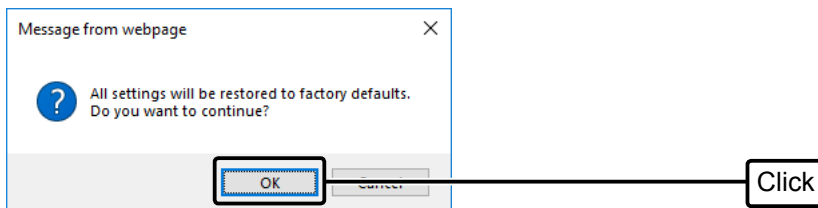

- The VE-PG4 restarts to restore the settings. It may take several minutes to completely reboots.

CAUTION: DO NOT turn OFF both the VE-PG4 and the PC while the VE-PG4 is restoring or rebooting.

- 4 After the VE-PG4 has completely rebooted, click “[Back]” (the red text on the screen) to return to the setting screen.

Factory Defaults options

- All Settings: Restores all the settings to the factory defaults. The IP address of the VE-PG4 will be reset to “192.168.0.1.”
- V/RoIP Settings: Restores the factory defaults other than the settings in the Network Settings, Router Settings, and Management menus. The setting for the wireless LAN transceivers and the PBX will be reset.

Updating the firmware

You can update the firmware of the VE-PG4 in 4 ways.

- Manual update: In the case that the RoIP gateway cannot do the automatic update, first download the latest firmware from the Icom website, and then manually load the saved firmware. (p. 5-7)
- Online update: Automatically updates the firmware through the 4G or 3G line or the Internet. (p. 5-8)
- Pushing <UPDATE>: Manually update the firmware by pushing <UPDATE> button on the front panel of the RoIP Gateway. (p. 5-9)
- Using the USB flash drive: Manually update the firmware from the USB flash drive. (p. 5-15)

TOP

■ About the firmware

The firmware is a fundamental program for the RoIP Gateway, and internally saved on the flash memory. The firmware may be updated when the functions and specifications of the RoIP Gateway are improved. Ask your dealer for updated function or specification details.

System Status	
Host Name	VE-PG4
Version	<input type="text" value=""/>
IP100H Firmware Version	1.10
Current Time	2016-05-03 14:00:00
Uptime	0 day 02:00:37
Memory Usage	445396 kB / 993568 kB (44% used)

Firmware version

NOTE:

- NEVER turn OFF the power until the updating has been completed. Otherwise, the VE-PG4 may be damaged.
- If the firewall is running, stop it before updating the firmware. If you want to stop the firewall, ask your network administrator for the detail.
- Icom is not responsible on the consequence of the updating the firmware.

Updating the firmware

Management > Firmware Update

Manual update

Before updating the firmware, save the current setting into a file.

NOTE: Some settings may be returned to their defaults after the firmware update. Refer to the Icom website for details.

TIP: In order to protect the RoIP Gateway from maintenance by unknown users, Icom recommends restricting access to the setting screen during normal use.

- 1 Open the Firmware Update screen.
(Management > Firmware Update)
- 2 In [Manual Update], click <Browse...>, and then select the firmware file (extension: "dat").
 - The selected file appears in the "Update Firmware using File" item.



- 3 After the update is complete, click [Back].
 - Returns to the setting screen.
 - If the setting screen is not displayed, the update may not be completed. Wait for a few minutes, and then click [Back] again.

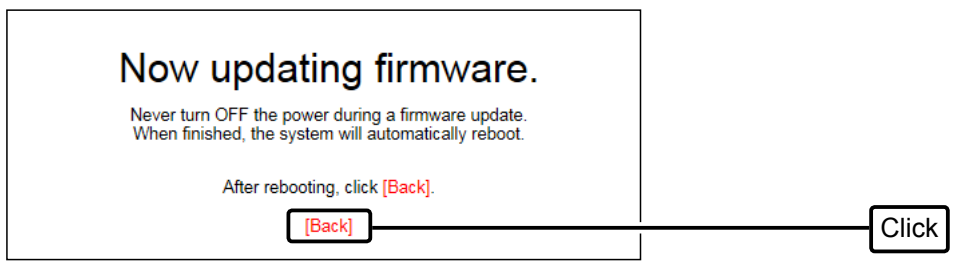

CAUTION: DO NOT turn OFF the RoIP Gateway and the PC while updating the firmware. It will cause data corruption, or damage.

If you cannot access the RoIP Gateway setting screen after the updating, the IP address of the RoIP Gateway may be reset to the default (192.168.0.1). Set your PC's IP address to the same network domain (for example: 192.168.0.100) and access the RoIP Gateway. After changing the RoIP Gateway's address properly, return the PC's address according to your network environment.

Updating the firmware

Management > Firmware Update

■ Online update

You can automatically check whether a new firmware version is available or not by pushing the <UPDATE> button on the front panel of the RoIP Gateway.

The [MSG] indicator on the front panel of the RoIP Gateway lights green if there is an Online update.

Information

- The DNS and the default gateway must be set to the RoIP Gateway in order to use the Online update through the Internet or a 4G/3G line.
- When a SIM card is inserted, the Automatic Update Setting is not displayed.
- Before the Online update, we recommend that you save your RoIP Gateway settings for a backup.

1 Open the Firmware Update screen.
(Management > Firmware Update)

2 In [Online Update], click <Check> to check if there is an available firmware update.

① If there is no update, "No Firmware update" is displayed or the [MSG] indicator does not light.

The image shows two screenshots of the device's web interface. The top screenshot is titled 'Online Update' and contains a 'Check for Updates:' label and a 'Check' button. A callout box with a circled '1' and the word 'Click' points to the 'Check' button. A blue downward arrow indicates the transition to the second screenshot. The second screenshot is titled 'Firmware Information' and shows a table with columns for Status, Version, and Changes. The Status cell contains the text 'Succeeded in gathering information.' A callout box with a circled '2' and the word 'Confirm' points to the Status cell. Below the table are 'Refresh' and 'Update Firmware' buttons.

3 Click <Update Firmware>.

- The RoIP Gateway starts accessing the Icom server to download the updates.
- ① Depending on the firmware version, the RoIP Gateway may require that you initialize the settings.
Before the Online update, we recommend that you save your RoIP Gateway settings for a backup.

4 After the update is complete, click [Back].

- Returns to the setting screen.
If the setting screen is not displayed, the update may not be completed. Wait for a few minutes, and then click [Back] again.

The image shows a screen with the heading 'Now updating firmware.' Below the heading is the text: 'Never turn OFF the power during a firmware update. When finished, the system will automatically reboot.' At the bottom, it says 'After rebooting, click [Back].' A callout box with the word 'Click' points to the '[Back]' button.

Updating the firmware

Management > Firmware Update

■ Online update with the <UPDATE> button

You can check whether a new firmware version is available or not by pushing the <UPDATE> button on the front panel of the RoIP Gateway.

The [MSG] indicator on the front panel of the RoIP Gateway lights green if the firmware is ready for an online update.

- ① When a SIM card is inserted, the Automatic Update Setting is not displayed.
- Automatically updates the firmware through

1 Hold down <UPDATE> with a pin until the [MSG] indicator blinks green.

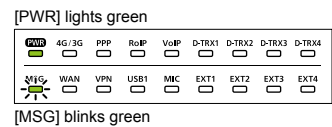
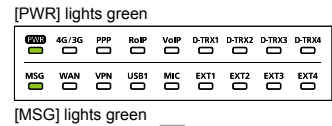
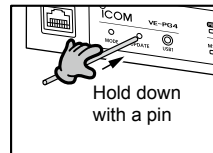

2 After the [MSG] indicator blinks green, release the <UPDATE> button.

- The RoIP Gateway starts downloading the new firmware, automatically installs it, and reboots.
- ① Restart your PC after the RoIP Gateway has completely rebooted.

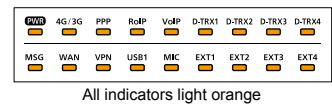
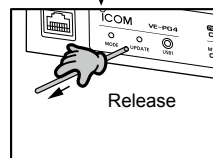

[PWR] lights green after rebooted

① The other indicator status other than [MSG] differ, depending on your system environment.

Automatic Restoring from a USB flash drive

You can load the VE-PG4's settings or update firmware, that are saved on a USB flash drive (user supplied). This is useful for cloning the settings to 2 or more VE-PG4s.

■ Using a USB flash drive

Before inserting the USB flash drive:

- Backup the current setting of the RoIP Gateway and the contents in the USB flash drive.
- Confirm the [USB] indicator is not lit, to prevent data corruption.

When inserting or removing the USB flash drive:

- Either one of the USB slots accepts the USB flash drive, but insert only one USB flash drive at a time.
- Insert the USB flash drive firmly and securely, until the [USB] indicator lights green.
- NEVER remove the USB flash drive or turn OFF the RoIP Gateway while transferring data (the [MSG] indicator blinks while transmitting.) It will cause data corruption, or damage the USB flash drive.
- After the firmware update is completed, check the firmware version on the setting screen to verify that the update was correctly done.

NOTE for updating the settings or the firmware:

- The firmware or the setting file will not be updated when:
 - The source data in the USB flash drive is as same as the current settings or firmware.
 - The source data is damaged.
 - The source data is not for the VE-PG4.
- When both the firmware and settings for the VE-PG4 are saved in the USB flash drive, the firmware will be updated after the settings data is loaded.
- When restoring the setting data from a USB flash drive to the RoIP Gateway, its original settings is automatically saved as "bakdata.sav" into the USB flash drive, as a backup.

■ Usable USB flash drive specifications

- Interface: USB 3.0 / 2.0 / 1.1
- Device: USB flash drive (USB Mass Storage Class)
- File format: FAT16/FAT32 (exFAT and NTFS are not supported)

① A USB flash drive such as one with biometric authentication, or one with password protection is not supported.

① Self-power supply may be required, depending on the device's current consumption.

Automatic Restoring from a USB flash drive

■ About the file names

The files that are saved on a USB flash drive for the automatic restore function must be named as follows:

- Settings file: savedata.sav
 - ① Only the settings file that is saved on the VE-PG4 setting screen can be used for the Automatic Restore function.
(Management > Settings Backup > Settings Backup)
- Firmware: firmware.dat
 - ① Use the downloaded firmware from the Icom web site.
Download the firmware file, extract it, and then rename the file to “firmware.dat”.

■ The settings backup files

When restoring the setting data from a USB flash drive to the RoIP Gateway, its original settings are automatically saved as “bakdata.sav” onto the USB flash drive, as a backup. The latest 11 backup files (revisions) are stored on the USB flash drive, as the file name “bakdata_X.sav” (X=Revision number.)

(Example) The latest backup: bakdata.sav (without a revision number)
The second backup: bakdata_1.sav
The third backup: bakdata_2.sav
:
The oldest (11th) backup: bakdata_10.sav

- ① If the content of the settings file is the same as the VE-PG4’s current settings, no setting backup file is saved.
- ① The firmware is not backed up.
- ① When a VE-PG4 setting is changed, the original settings are automatically saved onto the USB flash drive, if it is inserted into the VE-PG4.

Automatic Restoring from a USB flash drive

■ Managing 2 or more VE-PG4s with a USB flash drive

You can backup or restore the setting files for 2 or more VE-PG4s by making a separate folder for each VE-PG4. Before inserting the USB flash drive into the VE-PG4, make folders that are named the same as the MAC address for the LAN of the VE-PG4s that you want to manage with the drive.

Example: Managing the 3 of VE-PG4s whose MAC addresses are as follows:

- **A:** 00-90-C7-00-00-11
- **B:** 00-90-C7-00-00-22
- **C:** 00-90-C7-00-00-33

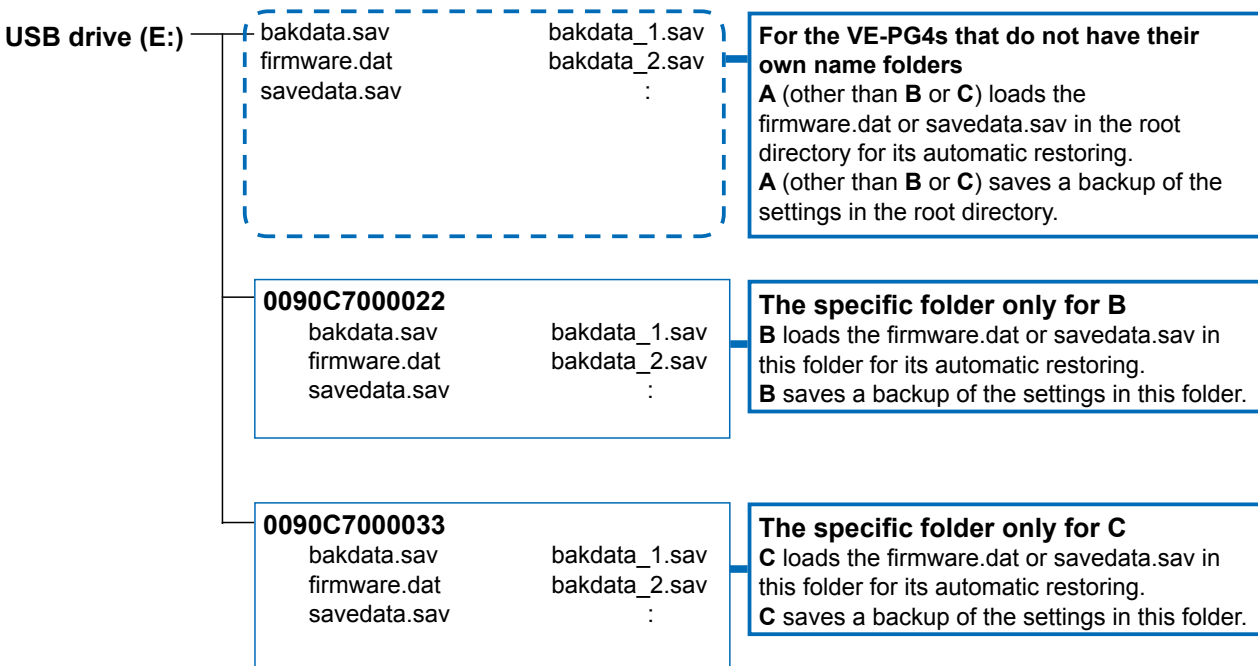

Restoring the settings from the USB flash drive

Management > Settings Backup/Restore

You can copy a RoIP Gateway settings to use to clone another gateway, with a USB flash drive. First, save the settings data of that you want to copy from onto the USB flash drive, then load the settings to another RoIP gateway.

- 1 Insert the USB flash drive to your PC.
- 2 Access the setting screen of the RoIP Gateway.
- 3 Open the Settings Backup/Restore screen.
(Management > Settings Backup/Restore)
- 4 In [Settings Backup], click <Backup>.

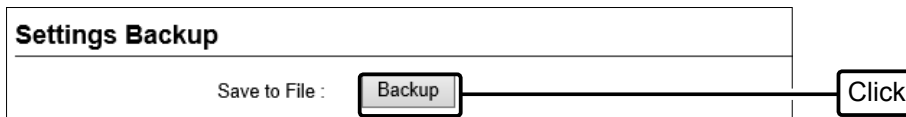

- The dialog is displayed.

- 5 Click “▼” of <Save>, select “Save as.”

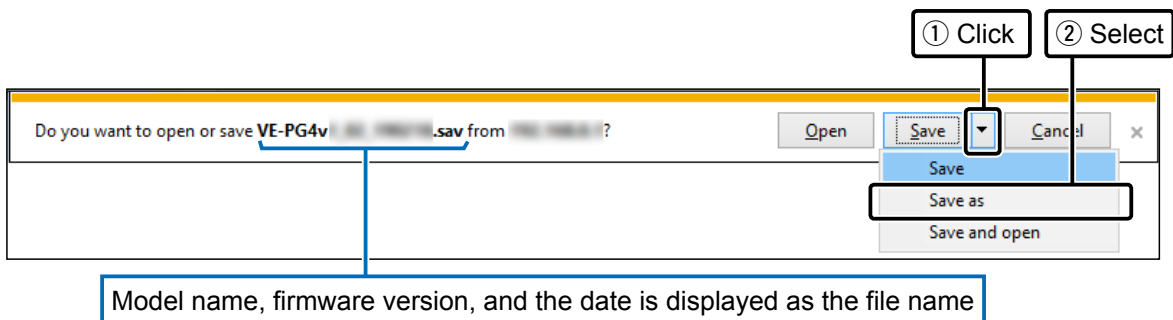

- 6 Select the appropriate folder (or root folder) in the USB flash drive, enter “savedata.sav” for the file name, and then click <Save>.

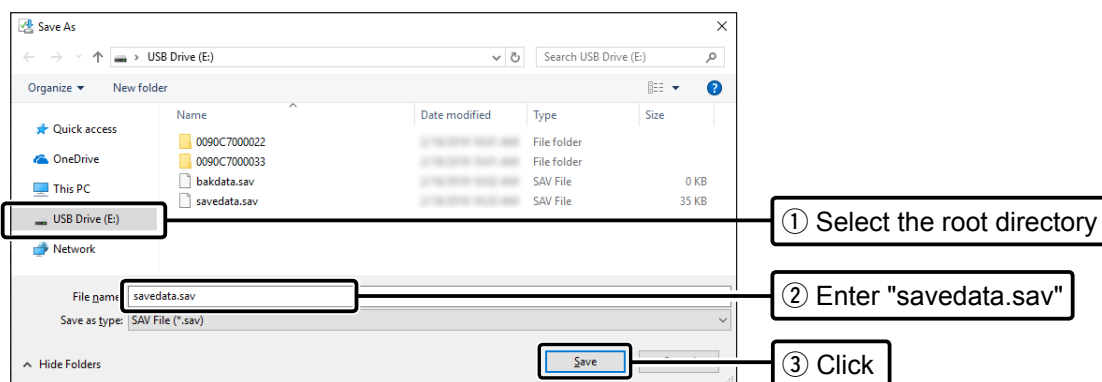

(☞ Continued on the next page)

Restoring the settings from the USB flash drive

Management > Settings Backup/Restore

- 7 Unmount and remove the USB flash drive from the PC.
- 8 Locate the VE-PG4 that you want to load settings from the USB flash drive.
- 9 Insert the USB flash drive to the VE-PG4. (Example: the [USB1] port)
 - The [USB1] indicator lights green when the USB flash drive is successfully mounted.

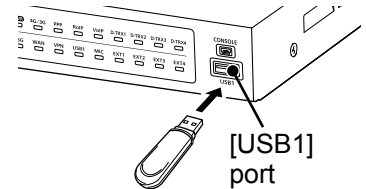

- 10 Push the <USB> button.
 - The VE-PG4 starts reading the settings from the drive.
 - After the settings are loaded successfully, the VE-PG4 restarts.

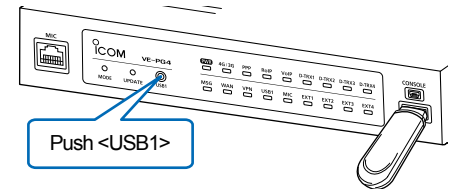

- 11 Confirm the [PWR] indicator lights green, and hold down <USB1> button until the [USB1] indicator turns OFF. Confirm the [USB1] indicator turns OFF, and then remove the USB flash drive from the VE-PG4.

① The automatically saved VE-PG4 settings data is located as the bakdata.sav on the USB flash drive,

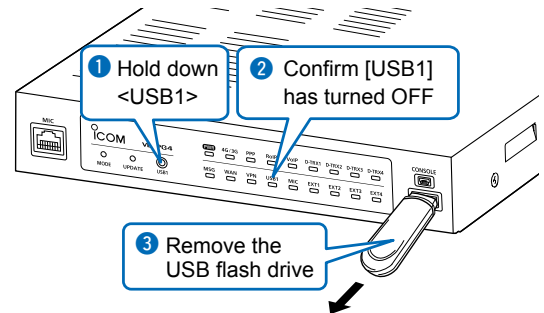

CAUTION:

- **DO NOT** remove the USB flash drive or turn OFF the VE-PG4 until the setting file is completely restored. Otherwise the settings data or the VE-PG4 may be damaged.
- **DO NOT** access the VE-PG4 setting screen until it is completely rebooted.
- Before removing the USB flash drive, confirm the [USB] indicator is not lit.

TIP: When the USB flash drive is enabled

(Management > Management Tools > USB)

If the VE-PG4 reboots while a USB flash drive is attached, the VE-PG4 starts reading from the USB flash drive.

Updating the firmware from a USB flash drive

You can update the RoIP Gateway firmware by using a USB flash drive (user supplied). Download the firmware and save it into the USB flash drive as follows, and then update the RoIP Gateway. Also, refer to the “Automatic Restoring from a USB flash drive” and “Updating the firmware” former in this section.

- 1 Download and extract the VE-PG4 firmware from the Icom web site.
- 2 Save the firmware data onto the USB flash drive, with the file name “firmware.dat.”
 - ① If there is a specific folder of the VE-PG4, save the firmware into the folder.
 - ② The VE-PG4 cannot read the firmware from the other file than “firmware.dat.”

- 3 Select the VE-PG4 to update the firmware.

- 4 Insert the USB flash drive into the USB port (example: USB1 port) of the VE-PG4.

- The [USB1] indicator lights green when the USB flash drive is successfully mounted.

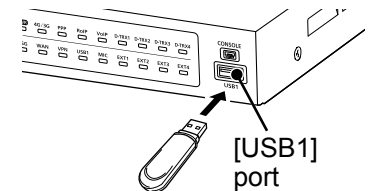

- 5 Push the <USB1> button.

- The VE-PG4 reboots to update the firmware.

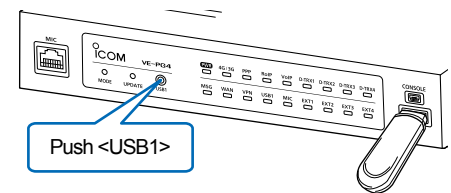

- 6 Confirm the [PWR] indicator lights green, and hold down <USB1> button until the [USB1] indicator turns OFF. Confirm the [USB1] indicator turns OFF, and then remove the USB flash drive from the VE-PG4.

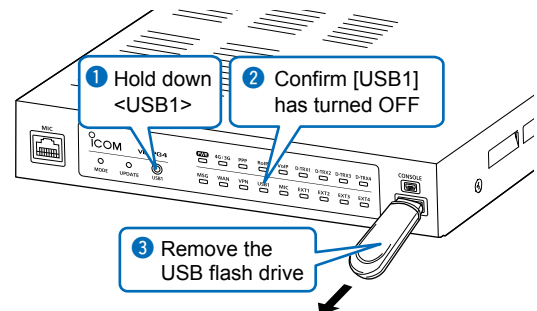

- 7 Confirm the firmware version of the VE-PG4 on the setting screen. (TOP > System Status)

CAUTION:

- **DO NOT** remove the USB flash drive or turn OFF the VE-PG4 until the firmware is completely updated. Otherwise the settings data or the VE-PG4 may be damaged.
- **DO NOT** access the VE-PG4 setting screen until it is completely rebooted.
- Before removing the USB flash drive, confirm the [USB] indicator is not lit.

Issuing a USB authentication key

Management > Management Tools

By setting an authentication key and saving it to a USB flash drive, you can securely authenticate the USB flash drive that is used for automatic backup and restore, or updating the firmware. When the USB authentication key is set, the VE-PG4 reads or writes the setting data or the firmware from/to only the USB flash drive that has a matching authentication key.

- 1 Insert the USB flash drive into the USB port (example: USB1 port) of the VE-PG4.

- The [USB1] indicator lights green when the USB flash drive is successfully mounted.

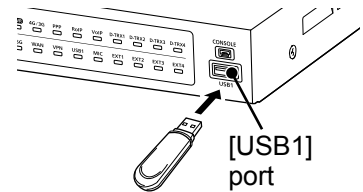

- 2 Open the Management Tools screen of the RoIP Gateway setting screen. (Management > Management Tools)

- 3 In [USB], enter the USB Authentication Key of up to 64 characters, and then Click <Apply>.

USB

USB Flash Drive : Disable Enable

USB Access Permission : Firmware Update
 Settings Backup/Restore

USB Authentication Key: ① Enter

Write USB Authentication Key:

Check Status :

Confirmation State :

② Click

- 4 Click <Write>.

USB

USB Flash Drive : Disable Enable

USB Access Permission : Firmware Update
 Settings Backup/Restore

USB Authentication Key:

Write USB Authentication Key: Click

Issuing a USB authentication key

■ Managing 2 or more VE-PG4s with a USB flash drive

5 When the following dialog is displayed, click <Next>.

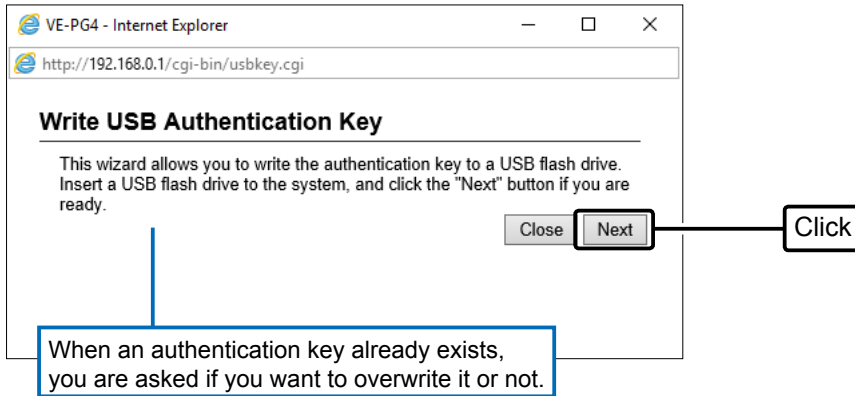

Click <Close>.

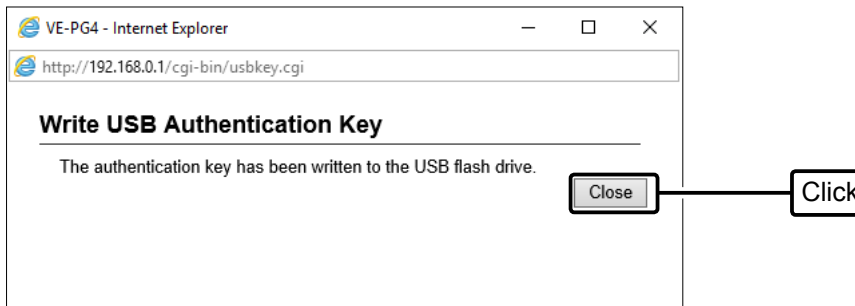

6 Confirm the [PWR] indicator lights green, and hold down <USB1> button until the [USB1] indicator turns OFF. Confirm the [USB1] indicator turns OFF, and then remove the USB flash drive from the VE-PG4.

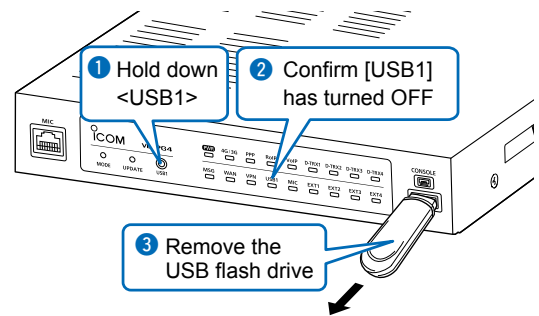

Troubleshooting	6-2
Accessing with Telnet/SSH	6-4
■ Accessing the VE-PG4 with Telnet/SSH	6-4
■ About Telnet/SSH commands	6-4
■ Using the [CONSOLE] port	6-5
The setting screen menu list	6-6
The feature functions	6-12
About the external audio device.....	6-13
■ Connecting to an external audio device	6-13
Using the Virtual serial port.....	6-14
■ Preparation on the VE-PG4	6-15
■ Installing the Virtual serial port	6-16
■ Deleting the Virtual serial port	6-18
Specifications	6-19
■ General	6-19
■ Communication interfaces	6-19
■ Port details	6-20

Troubleshooting

The following conditions are not due to a malfunction. Check before sending a request for repair.

The [POWER] indicator does not light

- The power adapter is not connected.
 - Check the adapter or DC jack connection.
- The power adapter is connected to the same power outlet used by the PC.
 - Connect the power adapter to a different power outlet.

The [LAN] indicator (On the rear panel) does not light

- The Ethernet cable is not properly connected to the VE-PG4.
 - Make sure the Ethernet cable is securely connected.
- The HUB or PC is turned OFF.
 - Turn ON the HUB or PC.

The setting screen does not open properly

- The JavaScript or Cookie functions are turned OFF.
 - Turn the functions ON.
- Your Microsoft Internet Explorer version is 10 or earlier, or your browser is other than Internet Explorer.
 - Use Microsoft Internet Explorer 11 or later.

Cannot access the VE-PG4's setting screen

- The PC's IP address is incorrect.
 - Set a static IP address to the RoIP Gateway and the PC.
- The network part of the PC's IP address is different from that of the RoIP Gateway.
 - Set the network part of PC's IP address to same as that of the RoIP Gateway.
- A proxy server is set in the web browser setting.
 - Disable the web browser's proxy server setting.
 - Click "Tools" in the web browser menu, and then click "Internet option."
 - Click the "Connections" tab, then click <LAN settings>, and then confirm there is no check mark in "Automatically detect settings" and "Use a proxy server for your LAN."

Cannot connect to the Internet

- The internet connection is currently out of service.
 - Ask your ISP for the connection status.
- The MAC address is not registered to your ISP.
 - Some ISPs require WAN MAC address registration.
- When using a Bridge modem or DCE (FTTH), the wrong connecting method is set.
 - Ask your ISP for the connection type (DHCP Client, Static IP or PPPoE).
- The broadband modem or DCE (FTTH) is not correctly connected to the RoIP Gateway.
 - If you use a Bridge modem or DCE (FTTH), set the connection type as specified by your ISP.
- IP address is not obtained from WAN (ISP)
 - Check the connection between RoIP Gateway and DCE (FTTH).
 - The IP address obtained from the WAN is displayed in the "Connection Status" on the WAN screen.
- The DNS server address is not properly set.
 - Check the set DNS server address in the "Network Settings" menu or the "Router Settings" menu.

Cannot access the RoIP Gateway through the [WAN/LAN] port while the Router function is in use

- The default IP filter setting blocks the packets from the [WAN] port.
 - Change the IP filter setting.
- ① Icom is not responsible for any accidents caused by the security degradation.

Troubleshooting

The inserted USB flash drive is not recognized

- The USB function is set to “Disable.”
 - Enable the USB Flash Drive setting on the Setting screen.
(Management > Management Tools > USB > USB Flash Drive)

Cannot cancel an outgoing call

- The RoIP Gateway cannot recognize the calling status.
 - Enable SIP 183 Support setting on the Setting screen.
(PBX Advanced Settings > Advanced Settings > SIP Settings > SIP 183 Support)

[Input/Output Digital Gain] doesn't work

- Internal codec is not used.
 - Use [Input/Output Analog Gain] to adjust the signal level.

The receiving sound breaks up while operating in the Bridge's Multicast mode

- Two or more transceivers that are connected through different RoIP Gateways are transmitting at the same time.
 - Use only one RoIP Gateway in the Always-on connection mode.
 - Set the Always-on connection mode to disable.

The output audio signal from the [OUT] port does not fade-in or fade-out

- The [EXT] (1 ~ 4) port setting is incorrect.
 - Set the [EXT Input] port's connect destination to [EXT Output].

The RoIP Gateway does not automatically update the firmware (When no SIM card is attached)

- The Ethernet cable is not properly connected to the RoIP Gateway.
 - Properly connect the Ethernet cable to the RoIP Gateway.
- The RoIP Gateway is not connected to internet.
 - Set the RoIP Gateway properly to connect to internet.
- The firewall is running.
 - Stop the firewall. If you want to stop the firewall, ask your network administrator for details.

Communication is unstable

- [4G/3G] is OFF or blinking. (Signal is weak.)
 - Locate the RoIP Gateway to place where it can receive a stronger signal.

4G or 3G line communication is not established

- The [PPP] indicator is OFF.
 - Check if the [4G/3G] lights.
 - Ask your 4G/3G line service provider for the connection status.

Accessing with Telnet/SSH

■ Accessing the VE-PG4 with Telnet/SSH

Use Telnet according to your OS or Telnet/SSH client.

- ① You can not access from the Telnet client because the “Telnet” setting of the RoIP Gateway is disabled by default. Enable it to access from the Telnet client. (Management > Management Tools > Telnet/SSH)
- ① The RoIP Gateway supports UTF-8 character codes. Use a terminal software that supports UTF-8.

How to login:

1. Enter the login name, and then push the [Enter] key to log in.
 - Login: admin (Fixed)
 - Password: admin (Default)
 - Enter the administrator password set on the Administrator screen.
(Management > Administrator > Administrator Password)
2. If Telnet/SSH is successfully connected to the RoIP Gateway, “VE-PG4>” is displayed.

Saving the setting:

After making changes, enter “save,” and then push the [Enter] key.

How to log out:

Enter the command “quit,” “exit,” or “logout” to log out from the RoIP Gateway.

■ About Telnet/SSH commands

Command list	Push the [Tab] key to display the Telnet command list. After typing a Telnet command, push the [Tab] key to display the subcommand list.
Command help	Enter “?” after a command to display the command description. (Example) “save ?” (“save” command description is displayed.)
Automatic complement	After typing the first few characters of the command, push the [Tab] key. The rest of the characters for the command are automatically entered. (Example) “n” + [Tab] → network Suggested commands are displayed. (Example) “res” + [Tab] → reset restart

Accessing with Telnet/SSH

■ Using the [CONSOLE] port

You can control the RoIP Gateway using the terminal software by connecting the [CONSOLE] port of the RoIP Gateway to a USB port of the PC through a USB (Mini-B) cable (user supplied).

The USB driver for the Icom network devices is required.

Download the USB driver and the manual from the Icom web site and install it according to the manual.

<http://www.icom.co.jp/world/support>

After installing the USB driver, set the serial port settings in the terminal software as follows:

- Port: Check the COM port number setting on your PC
- Baud rate: 115200 bps
- Data: 8 bit
- Parity: None
- Stop: 1 bit
- Flow control: None

When the COM port setting is finished, press the [Enter] key to display the "VE-PG4 login:" prompt.

The setting screen menu list

The list of the menu items, displayed on the VE-PG4 setting screen by default.

Menu	Setting screen	Setting item
TOP	TOP	System Status
		MAC Address
		WAN Status
		LTE Status
Information	Network Status	Interface List
		Ethernet Port Connection Status
		DHCP Lease Status
		SYSLOG
	Bridge Status	Bridge Status
		Port Connection Status
	PBX Status	Extension Group List
		List of Extensions
	Call Log	Call Log
	Extension Status	Extension Status
	LTE Status	LTE Module Status
SIM Status		
LTE Status		
Network Settings	IP Address	Host Name
		IP Address
	DHCP Server	DHCP Server
		Static DHCP
		List of Static DHCP Settings
	Static Routing	Routing Table
		Static Routing
		List of Static Routing Entries
	Policy Routing	Source Address Routing
		List of Source Address Routing Entries
Router Settings	WAN	Connection Status
		Connection Type
	NAT	NAT
		DMZ Host
		Port Forwarding
	IP Filter	List of Port Forwarding Entries
		General Settings
		IP Filter
	Simple DNS	List of IP Filter Entries
		Simple DNS Server Settings
VPN	List of Simple DNS Server Settings	
	IPsec Settings	
	IPsec Tunnel Settings	
	List of IPsec Tunnel Settings	
Bridge Connection Settings	Bridge Connection	Bridge Connection
		Bridge Connection Entry List (For Combination)
		Bridge Connection Entry List (For Custom Bridge Connection)
		AMBE+2 Vocoder Assignment
	SelCall in Bridge Connection	Save or Write the Rule Settings for SelCall in Bridge Connection
		Rule Settings for SelCall in Bridge Connection
		List of Rule Settings for SelCall in Bridge Connection

The setting screen menu list

Menu	Setting screen	Setting item
Transceiver Controller	RoIP Settings	Additional Controller Settings
		Advanced Settings
	Tenant (Fleet) Settings	Tenant (Fleet)
	RoIP Server	Call Type Priority
	Additional Controller Link	Link Setting
		Linked Controller List
		Area Call
	Area Call	Area Setting
		Access Point Search
		Area Entry List
	Transceiver Management	Transceiver Management
	Transceiver Registration	Transceiver Settings
		Transceiver Setting Entry List
		TRX Batch Setting
	Transceiver Settings	Transceiver Settings
		Copy Transceiver Settings
		Transceiver Setting List
	Wireless LAN	Wireless LAN
		List of Wireless LAN Entries
	ID List	ID List Common Settings
		ID List Advanced Settings
		Save or Write the ID List Setting
		ID List
		ID List Entries
	Messages	Message Group
		Message Group Detail
		Save or Write the Message Setting
Message List		
Status	Status Settings	
Profile	Profile List	
	Profile	
	Profile Batch Setting	
Connection Port Settings	Digital Transceiver (D-TRX)	Digital Transceiver
		Digital Transceiver System
		Digital Transceiver Connection
		Communication Settings
		Bridge Communication
		DTMF Dialing
		EXT I/O (EXT)
	EXT I/O Port Mode	
	EXT I/O	
	Transceiver Model	
	Transceiver Connection	
	Bridge Communication	
	Transceiver Control	
	DTMF Dialing	
	PTT Control Setting	
	Receive Detection Setting	
	EXT I/O Device Connection	
	EXT I/O Control	
	EXT Input Settings	
	EXT Output Settings	
	Emergency Notification	Bridge Communication

The setting screen menu list

Menu	Setting screen	Setting item	
	Microphone (MIC)	Bridge Communication Microphone Control Microphone Input Control Voice Output Control	
	RoIP Gateway	RoIP Gateway RoIP Gateway Connection RoIP Gateway Communication RoIP Gateway Control Bridge Communication	
Destination Settings	SelCall Number Converting	Save or Write the SelCall Number Converting Setting SelCall Number Converting List of SelCall Number Converting Entries	
	Destination Settings	Destination Settings List of Destination Setting Entries (All Call) List of Destination Setting Entries (Group Call) List of Destination Setting Entries (Talkgroup Call) List of Destination Setting Entries (Multiplex Talkgroup Call) List of Destination Setting Entries (Individual Call) List of Destination Setting Entries (Telephone) Destination Batch Setting	
Expert Settings	Emergency Notification	Emergency Notification	
	Abnormal Condition Monitoring	LAN Port Link-down PING Test SIP Server Registration	
	IP Transceiver Status Filtering	IP Transceiver Status Filtering Filtering List Filtering List Batch Setting	
	Connection Port Extension	VoIP Settings	
	Call Recording	Common Setting Recorder Setting List of Recording Box Entries	
IP Line Settings	IP Line	SIP Server List of SIP Server Entries SIP Server Batch Setting	
		Peer to Peer	Peer to Peer Common Setting Peer to Peer List of Peer to Peer Entries
			VoIP Phonebook
	PBX	Basic	Basic
		Special Number	Common Special Number Telephone Special Number Transceiver Special Number Transceiver Call Prefix External Call Routing Number
			Extension
Extension Group			

The setting screen menu list

Menu	Setting screen	Setting item	
	Inbound Call	Inbound Call	
PBX Tranceiver Call Settings	Callee ID to Phone Number	Save or Write the Callee ID to Phone Number Setting	
		Callee ID to Phone Number	
		List of Callee ID to Phone Number Entries	
	Outbound Call Restriction	Outbound Call Restriction	
		Target ID Entry	
		List of Target ID Entries	
PBX Extension	Telephone (KX-UT Series)	Telephone Maintenance	
		Telephone Group	
		Telephone Individual Settings (KX-UT Series)	
		Dial Tone	
		Busy Tone	
		Reorder Tone	
		Ring Back Tone	
		Hold Alarm	
		Ringtone Pattern	
		Ringtone Pattern Assignment	
		Telephone Common Settings	
		Telephone Individual Settings (KX-UT Series)	
		Button Assignment	
		Telephone (KX-HDV Series)	Telephone Maintenance
			Telephone Group
	Dial Tone		
	Busy Tone		
	Reorder Tone		
	Ring Back Tone		
	Hold Alarm		
	Ringtone Pattern		
	Ringtone Pattern Assignment		
	Telephone Common Settings		
	Telephone Individual Settings (KX-HDV Series)		
	Expand Unit(KX-HDV230) (Expand Unit 1to 5)		Telephone Maintenance
		Telephone Group	
		Telephone Individual Settings (KX-HDV230)	
Phonebook	Select Group Setting		
	Save or Write the Phonebook		
	Phonebook Entry		
	List of Phonebook Entries		
Transceiver Controller Telephone Connection	Transceiver Controller Telephone Connection		
	Communication		
	Control		
	PTT Control Setting		
	Call Initiation Setting		
	Notice Tone on the Telephone		
	Release Timer		

The setting screen menu list

Menu	Setting screen	Setting item
	Converter Bridge	Converter Bridge Connection Communication Control DTMF Dialing PTT Control Setting Call Initiation Setting Notice Tone on the Telephone Release Timer
PBX Advanced Settings	Advanced Settings	SIP Settings VoIP Settings
	Prioritization	EXT Output Port Prioritization Caller Prioritization List of Caller Prioritization Entries
	Numbering Plan	Phone Number Routing Settings List of Phone Number Routing Settings Exception Outbound Phone Number Outbound Phone Number Reformatting Settings List of Outbound Phone Number Reformatting Settings Outbound Call Restriction Rule Settings List of Outbound Call Restriction Rule Settings
	Outside Line Regulation	Outside Line Regulation
	External Call Limiting	Overall Limitation Limitation for each Outside Line
	IP Authenticated Extension	IP Authenticated Extension (Pre-registered Extension) List of IP Authenticated Extension
	Caller Number Reformatting	Source Line Settings Caller Number Reformatting Settings List of Caller Number Reformatting Settings
	DID	DID Allocation DID Settings List of DID settings
Management	Administrator	Administrator Password
	Management Tools	USB HTTP/HTTPS Telnet/SSH Unit ID Confirmation
	Date and Time	Date and Time Time Zone NTP SNTP Server
	SYSLOG	SYSLOG
	SNMP	SNMP
	Network Test	Ping Test Traceroute Test
	Management LTE Module	Management LTE Network
	Reboot	Reboot
	Settings Backup/Restore	Settings Backup Settings Restore List of Settings
	Factory Defaults	Factory Defaults

The setting screen menu list

Menu	Setting screen	Setting item
	Firmware Update	Firmware Status
		Online Update
		Automatic Update
		Manual Update

The feature functions

Communication

- Radio communication with Icom transceivers
- External I/O Audio pass through
- Auto fader
- Priority Interrupt Calling
- Multicast mode
- Unicast mode
- Emergency calls
- VOX

Telephone

- Extension registration (SIP:25)
- Connection to up to 100 upstream SIP servers
- Extension group
- Multiple line key
- Call park / retrieve
- Call pickup
- Hold and forward
- Blind transfer / No answer transfer
- SIP phone settings
- Phonebook for KX-UT series and KX-HDV series
(Common: Up to 300 entries /
Group: Up to 100 entries)
- Peer to Peer (Up to 500 entries)
- Gateway connection
- Caller number reformatting
- Outbound number reformatting
- Outbound call restriction
- External line controls

Router

- PPPoE connection
- DHCP client
- Static IP connection
- IP masquerade
- Static IP masquerade
- DMZ
- DHCP server
- Static DHCP server
- Static routing
- Policy routing
- IP filter
- DNS proxy
- VPN

Network management

- SYSLOG
- SNMP (MIIB-II)

System management

- Communication between different locations
- Bridge connection to a VoIP system
- Wireless LAN transceiver controller
- Gateway for IP transceivers

Others

- Administrator Authentication
(Administrator ID/Password)
- Internal clock settings
- Firmware updates (Web/USB)
- Setting backup/restore (Web/USB)
- Browser maintenance (HTTP/HTTPS)
- Telnet maintenance (TELNET/SSH)
- Console maintenance (USB)
- Online Firmware updates (Manual/Automatic)
- Network monitoring
- Resist monitoring
- Route communication quality check
- Simplified audio recording

About the external audio device

■ Connecting to an external audio device

Connect the VE-PG4 to an external audio device, using the cable, with pin assignments as follows.
See page 6-20 for details on the port.

- ① The A2, A4, B4 terminals are GND (-).
- ① The B1–B4 terminals can be configured on the setting screen.

Connectors (Top panel)

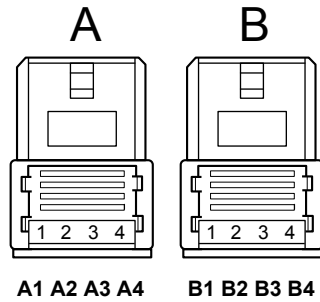

- A1/A2: Audio output (OUT)
- A3/A4: Audio input (IN)
- B1/B2: Relay circuit output
- B1/B4: Control output
- B2/B4: 8 V power supply
- B3/B4: Control input

Using the Virtual serial port

When using the Virtual Serial Port function of the VE-PG4, you can remotely control a device, that has a serial communication interface, through a TCP/IP connection.

The VE-PG4 supports up to 64 virtual serial ports.

To use the virtual serial port function, download the software from the Icom web site.

<http://www.icom.co.jp/world/support/>

System Requirements

Operating System

- Microsoft® Windows® 10 (32/64 bit)
- Microsoft® Windows® 8.1/8 (32/64 bit) except for the “RT” version
- Microsoft® Windows® 7 (32/64 bit: Service Pack1 or later)

Optional cable

- OPC-2389

Connect the VE-PG4 and the serial device using the modified RS-232C cable, as shown below.

Wiring (example: When Connecting DTE)

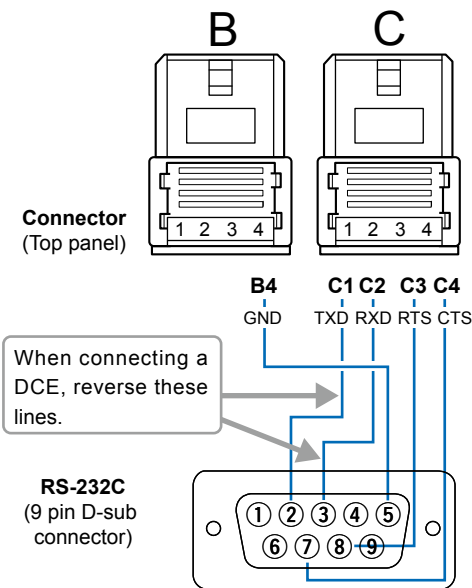

NOTE:

- Turn OFF both the VE-PG4 and the serial device before connecting or disconnecting the cable.
- A data transmission delay may occur as the data routes through the network. The error caused by the delay may be improved if the time out timer is set to a long value.
- Use a crossover cable when you connect a DCE (Data Circuit-terminating Equipment) to the VE-PG4.

Using the Virtual serial port

Connection Port Settings > EXT I/O (EXT)

■ Preparation on the VE-PG4

Before using the virtual serial port, enable serial communication on the VE-PG4 setting screen.

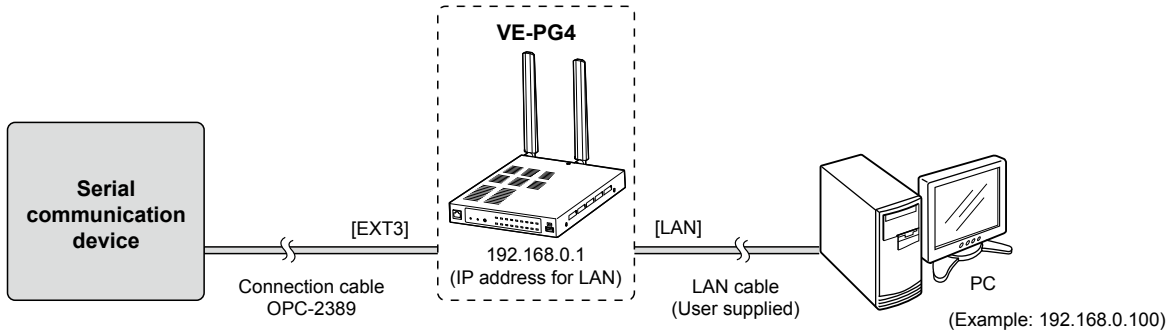

This is an example to connect a serial device to [EXT1] (lower slot) on the VE-PG4. Refer to the Operating guide for details on the serial communication.

- ① The required settings on the VE-PG4 vary, depending on the setting on the serial communication device.
 - When setting a serial communication device to “External I/O Unit”: In [EXT Output Settings]
 - When setting a transceiver model to “General Setting”: In [Transceiver Connection]

1 Open the [EXT I/O (EXT)] screen.
(Connection Port Settings > EXT I/O (EXT))

2 Select “EXT I/O3 (EXT3)”.

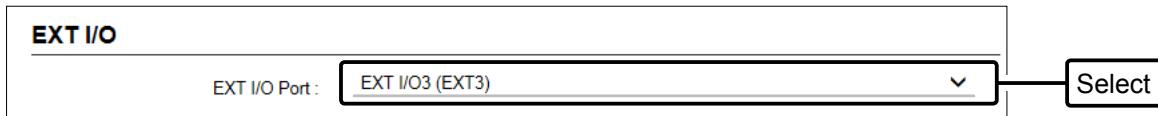

3 Set [EXT I/O] to “EXT I/O 3 (EXT3)” Enter the serial communication settings in the [EXT Output Settings] as follows.

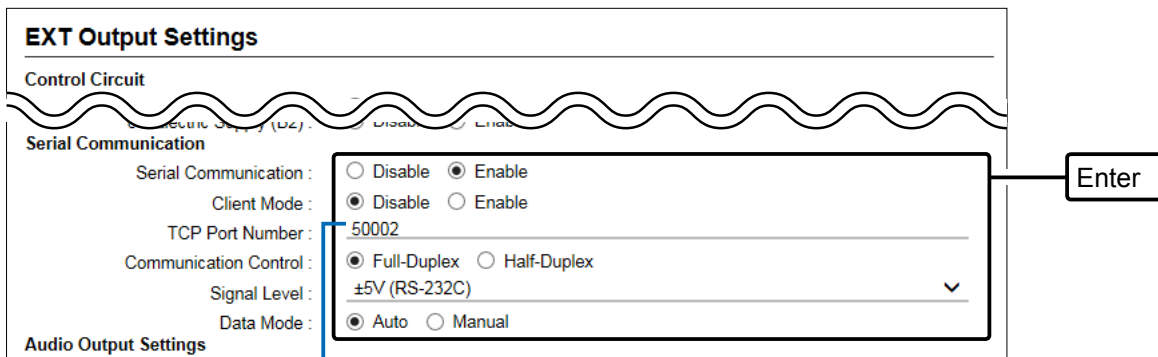

Enter the Virtual Serial Port number (p. 6-16)

4 Click <Apply> to apply the settings.

5 Confirm the displayed message, and then click <OK>.

Using the Virtual serial port

■ Installing the Virtual serial port

- 1 Log in to your PC as the administrator.
① Close all the other applications.
- 2 Extract the Virtual serial port software that was downloaded from the Icom web site, and open the extracted folder.
- 3 Double click “VirtualSerialPort.exe.”
 - The Virtual Serial Port application opens.
 - ① Click <Yes> in the “User account Control” dialog, if displayed.
- 4 Click<Add>.

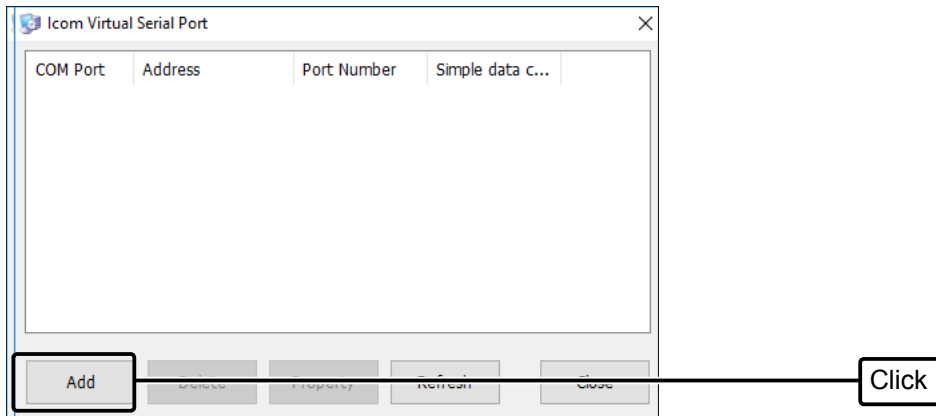

- ① You can add up to 64 virtual serial ports.
- ① If a security warning dialog is displayed or the application asks you to reboot the PC, follow the displayed instructions.

- 5 When the installation is finished, the COM port number(Example: COM7) will appear in the above window.
 - ① The COM port number may differ, depending on your PC environment.

- 6 Select a COM port, and then click <Properties>.

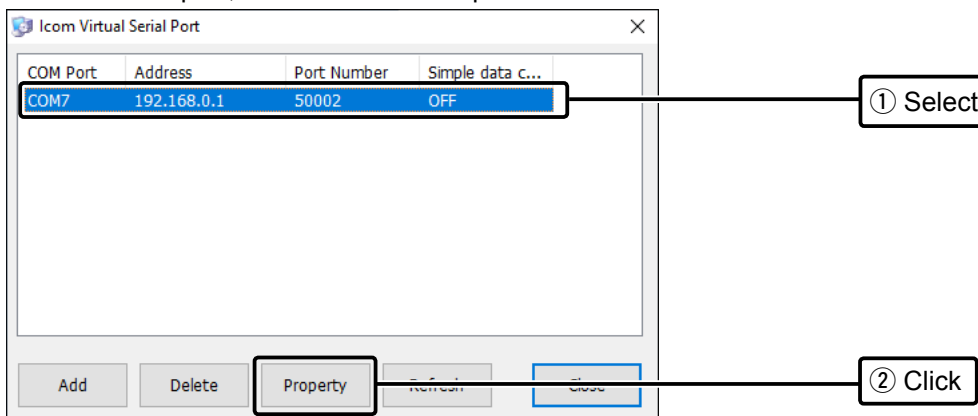

- ① You can also double click the COM port to open the properties window.

Using the Virtual serial port

■ Installing the Virtual serial port

7 Click “Port setting,” enter the IP address of the VE-PG4 and the TCP port number, and then click <OK>.

① Select

These settings are typically set by the applications that uses the serial communication. The values in this setting are not valid in that case.

② Enter

Uncheck when you set the Data Mode (p. 6-15) to “Auto.”

8 Confirm the port settings, and then click <Close>.

① Confirm

COM Port	Address	Port Number	Simple data c...
COM7	192.168.0.1	50002	OFF

② Click

Using the Virtual serial port

■ Deleting the Virtual serial port

- 1 Login your PC as the administrator.
① Close all the other applications.
- 2 Open the folder that contains Virtual Serial Port.
- 3 Double click “VirtualSerialPort.exe.”
 - The Virtual Serial Port application opens.
 - ① Click <Yes> in the “User account Control” dialog, if displayed.
- 4 Select a COM port that you want to delete (Example: COM7), and then click <Delete>.

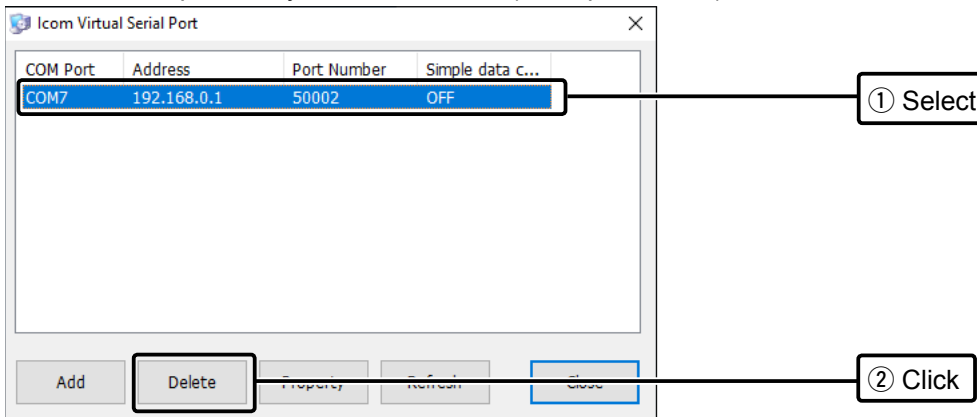

- ① It may take for a while to complete the deletion.
- ① You can select 2 or more COM ports by clicking the COM ports while holding down the [SHIFT] key.
- ① Restart the PC, if required.

Specifications

■ General

All stated specifications are subject to change without notice or obligation.

Power supply:	DC12 V \pm 10% [Polarity: \ominus — \oplus — \oplus] Maximum 55 W (with the supplied AC adapter)
Usable condition:	Temperature 0 to 40°C, +32 to +104°F, Humidity 5–95% (At no condensation)
Dimension:	Approximately 213 (W) \times 36.8 (H) \times 270 (D) mm, 8.4 (W) \times 1.4 (H) \times 10.6 (D) in (Projections not included)
Weight:	Approximately 1.8 kg, 4 lb (Without accessories)
Regulatory Compliance:	FCC Part 15 Class B/ ICES003,Part22,Part24,Part27, EN301 489-1,EN301 489-19,EN301 489-52, EN301 908-1, EN301 908-2, EN301 908-13, EN303 413,EN62479 EN62311,EN62368-1
Interface:	Indicators: (PWR, 4G/3G, PPP, RoIP, VoIP, D-TRX1~4, MSG, WAN, VPN, USB1, MIC, EXT1~4, USB2/3) Buttons: (MODE, UPDATE, USB1, USB2/3) [USB] ports: (USB A type, USB 3.0 \times 3 ports) [CONSOLE] port: USB mini B type, USB 2.0/1.1

■ Communication interfaces

Network ports:	[WAN/LAN] port (RJ-45 type) \times 1 (Auto MDI/MDI-X) [LAN] port (RJ-45 type) \times 1 (Auto MDI/MDI-X) • IEEE802.3/10BASE-T • IEEE802.3u/100BASE-TX • IEEE802.3ab/1000BASE-T
[EXT] (1~4) ports:	Audio input: -10 dBs/–40 dBs selectable Input impedance Approximately 10 k Ω unbalance Audio output: 0 dBs/–20 dBs selectable 600 Ω load unbalance/8 Ω 1 W speaker Control input: Low voltage contacts (DC3.3 V/ 1 mA)/ Voltage input (3–16 V) Control output: No voltage contacts (30 V/ 500 mA)/Open collector (3–16 V 10 mA) Connectors: 2.54 mm (0.1 in) pitch quick connector (4 terminals \times 3) \times 2
Communication rate:	10/100/1000 Mbps (Automatic switching/Full duplex)
Relay protocol:	Only IPv4 for routing
Signaling protocol:	SIP
Codec:	G.711u, AMBE+2

Specifications

■ Port details

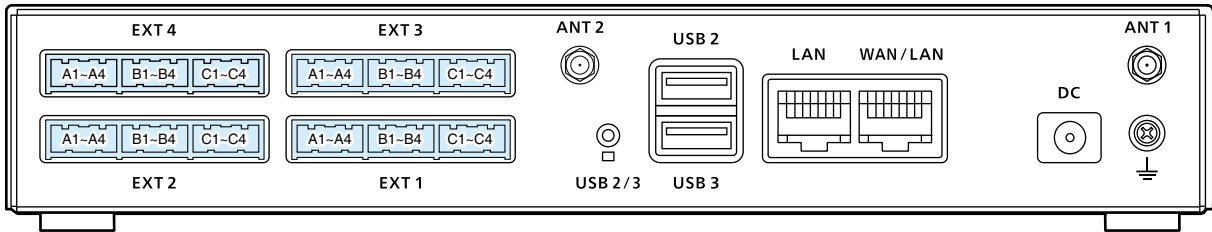

Pin No.	Description
A1	Analog audio output (From the VE-PG4) / Superimpose PTT
A2	Analog GND
A3	Analog audio input (To the VE-PG4) / Superimpose squelch detection
A4	Analog GND
B1	General control output / Single PTT control / Relay output
B2	Serial communication (Half duplex) / 8 V power supply / Relay output
B3	General control input / Single squelch control
B4	Common GND
C1	Serial communication TXD (From the VE-PG4)
C2	Serial communication RXD (To the VE-PG4)
C3	Serial communication RTS (From the VE-PG4)
C4	Serial communication CTS (To the VE-PG4)

① You can change the configuration of ports B1 to B4 on the VE-PG4 setting screen.

• **A1/A2 terminal (+/-) Audio output terminal**

Adjust the output gain according to the audio amplifier that is used.
 The connected audio equipment may be damaged if the gain is inappropriately set.
 The length of the cable that connects the audio equipment and VE-PG4 should be less than 10 m (3.3 ft.)
 Be careful of the noise and malfunction caused by a ground loop.
 Reference level: Speaker/0 dBs/-20 dBs(0 dBs = 0.775 Vrms) selectable
 Load impedance: More than 600 Ω (Speaker: 8 Ω)

• **A3/A4 terminal (+/-) Audio input terminal**

Adjust the output gain according to the audio amplifier.
 When you use a microphone other than an electret condenser microphone (ECM), select “Disable” on the setting screen.
 Reference level: -10 dBs/-40 dBs(0 dBs=0.775 Vrms) selectable
 Input impedance: Approximately 10 kΩ (Approximately 1 kΩ when biased)
 Supplied voltage: Approximately 2.2 V (For Electret Condenser microphone)

• **B1/B2 terminal (+/-) Relay output terminal**

Turns the connected equipment ON or OFF.
 • You can change the configuration of ports B1 to B4 on the VE-PG4 setting screen.
 (Connection Port Settings > EXT I/O (EXT))
 • Less than 30 V/500 mA.

Specifications

■ Port details

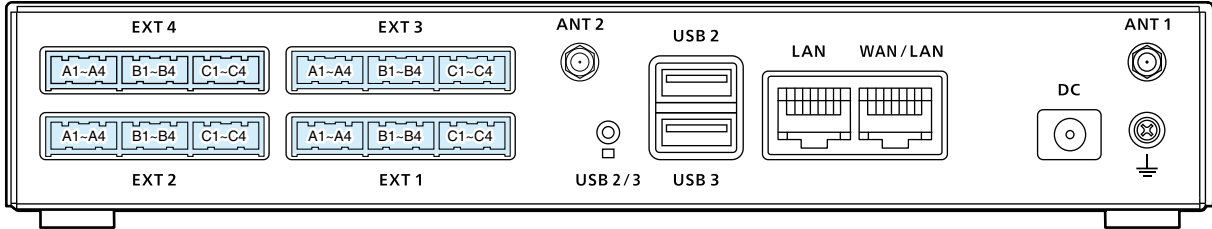

Pin No.	Description
A1	Analog audio output (From the VE-PG4) / Superimpose PTT
A2	Analog GND
A3	Analog audio input (To the VE-PG4) / Superimpose squelch detection
A4	Analog GND
B1	General control output / Single PTT control / Relay output
B2	Serial communication (Half duplex) / 8 V power supply / Relay output
B3	General control input / Single squelch control
B4	Common GND
C1	Serial communication TXD (From the VE-PG4)
C2	Serial communication RXD (To the VE-PG4)
C3	Serial communication RTS (From the VE-PG4)
C4	Serial communication CTS (To the VE-PG4)

① You can change the configuration of ports B1 to B4 on the VE-PG4 setting screen.

• B1/B4 terminal (+/-) General Control Output Terminal

Turns the connected equipment ON or OFF.

- You can change the configuration of ports B1 to B4 on the VE-PG4 setting screen.
- Specification: 3–16 V/10 mA (Open collector).

• B2/B4 terminal (+/-) 8 V Power Supply Terminal

Supplies the 8 V DC to the connected equipment.

- You can change the configuration of ports B1 to B4 on the VE-PG4 setting screen.
- Current limit: Less than 30 mA.

• B3/B4 terminal (+/-) General Control Input Terminal

Turns the connected equipment ON or OFF.

- You can change the configuration of ports B1 to B4 on the VE-PG4 setting screen.
- Specification: 3–30 V/10 kΩ (Voltage input).
- 3.3 V/less than 1 mA (Low voltage contacts).

Count on us!

